

enervent[®]

Ventilation unit with heat pump

Planning, installation and operational instructions manual

Before installing and operating this unit,
please read this manual thoroughly, and retain it for future reference.

EDX

www.enervent.fi

TABLE OF CONTENTS

OVERVIEW

TYPE MARKING 3

TYPE DESCRIPTION 3

FOREWORD 3

OPERATING PRINCIPAL 4

WARNING 4

THE SYSTEM

THE SYSTEM 5

LIST OF COMPONENTS 5

INSTALLATION

INSTALLATION OF THE EDX-SYSTEM 6

Installation of the outside unit

Piping and electrical wiring

PRINCIPAL CHART OF THE EDX-SYSTEM 7

DUCT HEAT INSULATION 8

STARTING THE SYSTEM 8

USING THE SYSTEM 9

TECHNICAL DATA

HEATING AND COOLING CAPACITY OF EDX COIL 10

CONTROL CHARTS 23

INTERNAL WIRING 24

INTERNAL AND EXTERNAL WIRING HRW AND HEAT PUMP 26

EXTERNAL WIRING 27

INSTRUCTIONS FOR SETTING PYR4 28

DECLARATION OF CONFORMITY 30

THE PARAMETERS OF EDA CONTROL 31

NOTE! All EDX-ventilation units are controlled with the EDA control. It is therefore important that You also read the EDA operation manual before starting up the system. In case the EDX and EDA operating manuals contain information about the same topic, the EDX-operating manual should be followed.

TYPE MARKING

Inside the ventilation unit is a type shield. Fill in the type shield's data here to have it easily available when it is needed, e.g. when buying new filters.

This manual covers the following units:

- Enervent® greenair Pingvin eco EDX-E
- Enervent® greenair Pandion eco EDX-E
- Enervent® greenair Pelican eco EDX-E
- Enervent® greenair Pegasos eco EDX-E
- Enervent® greenair Pegasos eco XL EDX-E
- Enervent® greenair LTR-3 eco EDX-E
- Enervent® greenair LTR-6 eco EDX-E
- Enervent® greenair LTR-7 eco EDX-E
- Enervent® greenair LTR-7 eco XL EDX-E



Example of serial number

Outside unit serial number:

TYPE DESCRIPTION

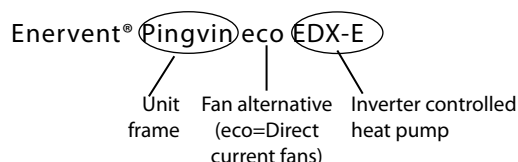

- eco Ventilation unit with direct current fans and EDA control.
- EDX-E Inverter controlled heat pump and electrical duct heater.

FOREWORD

The eco EDX-E ventilation units are designed and manufactured for use all year round. In Finland Enervent ventilation units have been installed in houses and other spaces for over 25 years and their popularity is increasing each year. Because of the knowledge and experience we have amassed during the years we can now manufacture more energy efficient and user friendly ventilation units. The Enervent eco EDX-E unit series is the result of a long product development.

A unit with basic functions can be pre-installed, by your self, with the help of this manual, but certain special functions and the extra equipment should be connected by an electrician. The installation of heat pumps requires a permission because it is a cooling apparatus. Installation of these apparatus should only be done by authorized installers. We recommend that the installation of the ventilation unit be performed by a qualified ventilation engineer. Before maintenance read the warning on next page!

THE WARRANTY WILL END IF THE INSTALLATION OF THE HEAT PUMP IS NOT CARRIED OUT BY A QUALIFIED COOLING INSTALLER!

OPERATING PRINCIPAL

The Enervent eco EDX-E ventilation units are a combination of regenerative heat recovery and an inverter controlled heat pump. A characteristic of the regenerative heat exchanger is its high rate of heat recovery (or efficiency). The system is realized with a rotating heat exchanger through which the supply and exhaust air flow in opposite directions. The outside air temperature is first raised in the rotating heat exchanger and then in the supply air coil. Heat is transferred from the outside unit to the supply air coil by the compressor benefitting from the change in the refrigerant's state. The refrigerant effectively binds heat when it changes from fluid to vapour. The heat is released when the refrigerant condensates back to fluid. In heating mode the refrigerant binds the heat when it evaporates in the outside unit. The refrigerant is pushed to the supply air coil by the compressor and condenses to fluid due to the pressure and releases the heat energy it has binded in the supply air. The heat pump's continuous heat production is once in a while interrupted by the defrosting function. At that time the process is temporarily turned to cooling to allow the ice formed on the outside unit to melt. The electric duct heater insures the supply air temperature stays at set level during the defrosting function and during very cold periods. The EDX-system is completely controlled by the automation. If the heat pump can not produce enough heat the automation will automatically switch on the duct heater.

In cooling mode the flow is turned around which means the refrigerant evaporates in the supply air coil binding heat energy and cooling the supply air. The heat energy is released from the refrigerant outside by the outside unit.

The EDX-E works as an additional heat source of the house as it economically produces over heated supply air with the heat pump technology. Further more the system effectively cools in the summer time. The used eco fans are energy efficient direct current fans.

WARNING

After opening the maintenance hatch wait for two (2) minutes before starting the maintenance work! The fans rotate for a while and the compressor can be searing hot even after the power is cut. There are no user-serviceable parts inside the control panel or inside the electrical cabinet, leave the service of these parts to a professional. It is important during troubleshooting not to turn on the power of the unit before being assured what the problem is.

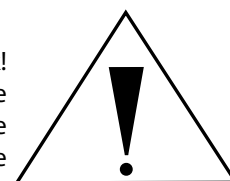

THE GREENAIR ECO EDX-E SYSTEM ASSEMBLY

ULKOYKSIKKÖ			
COMP 1	COMP 2	COMP 3	COMP 4
Pingvin eco EDX-E	Pegasos eco EDX-E	Pegasos eco XL EDX-E	Pegasos eco XL EDX-E (option)
Pandion eco EDX-E	LTR-7 eco EDX-E	LTR-7 eco XL EDX-E	LTR-7 eco XL EDX-E (option)
Pelican eco EDX-E		Pegasos eco EDX-E (option)	
LTR-3 eco EDX-E		LTR-7 eco EDX-E (option)	
LTR-6 eco EDX-E			

THE GREENAIR ECO EDX-E SYSTEM ASSEMBLY

		COMP 1 (RP-35)	COMP 2 (RP-50)	COMP 3 (RP-60)	COMP 4 (RP-71)
Compressor	Type	Rotation	Rotation	Rotation	Rotation
	Brand	Mitsubishi	Mitsubishi	Mitsubishi	Mitsubishi
Outside unit	Size H-W-D (mm)	600 - 800 - 330 (+23)	600 - 800 - 330 (+23)	943-950-330 (+30)	943-950-330 (+30)
	Net weight (kg)	45	45	75	75
	Nominal heating efficiency (kW)	4.1 (1.6-5.2)	6.0 (2.5-7.3)	7.0 (2.8-8.2)	8.0 (3.5-10.2)
	Nominal cooling efficiency (kW)	3.6 (1.6-4.5)	4.9 (2.3-5.6)	6.0 (2.7-6.7)	7.1 (3.3-8.1)
	COP heating *	~ 3.75	~ 3.85	~ 4.00	~ 4.00
	Sound level (dBA) heating/cooling	46/44	46/44	48/47	48/47
	Refrigerant	R410A	R410A	R410A	R410A
Piping	Refrigerant amount (g)	2 500	2 500	3 500	3 500
	Pipe size fluid	Ø 6,35/0,8 mm (1/4")	Ø 6,35/0,8 mm (1/4")	Ø 9,52/0,8 mm (3/8")	Ø 9,52/0,8 mm (3/8")
	Pipe size gas	Ø 12,7/0,8 mm (1/2")	Ø 12,7/0,8 mm (1/2")	Ø 15,88/0,8 mm (5/8")	Ø 15,88/0,8 mm (5/8")
	Max. length (m)	20	20	20	20
	Max. height difference (m)	10	10	10	10
Surrounding temp. (°C)		-25°C ... +43°C	-25°C ... +43°C	-25°C ... +43°C	-25°C ... +43°C
Outside unit supply (Ph/V/A)		1~ / 230 VAC / 16 A	1~ / 230 VAC / 16 A	1~ / 230 VAC / 20 A	1~ / 230 VAC / 20 A

* Incoming air temperature +15°C (coil). Outside air temperature -10°C (COP can vary depending on air amounts).

LIST OF COMPONENTS

THE EDX-E DELIVERY INCLUDES:

1. Supply air coil. Built-in or duct coil depending on unit model
2. Outside unit Mitsubishi PUHZ-RP
3. Control unit Mitsubishi PAC-IF011/12B-E
4. Sensors 3 pcs
5. Electrical duct heater

A list of the components included in the ventilation unit delivery is found in the ventilation unit manual.

INSTALLATION OF THE EDX-SYSTEM

The ventilation unit is installed according to the separate manual delivered with it. NOTE! LTR-6 and LTR-7 units have to be installed with the service hatch on the side if they are equipped with EDX. If the supply air coil isn't built-in, it is to be installed in the duct. Note point 3 here under. Because the EDX system is a cooling system, it has to be drained through a water lock. The drainage is situated on the duct coil or in the bottom of the ventilation unit.

Phases of installation:

1. Install the ventilation unit as advised in the separate manual delivered with the unit. NOTE! LTR-6 and LTR-7 units have to be installed with the service hatch on the side if they are equipped with EDX. Take into consideration the space needed for draining the condense water.
2. Make sure that there is enough free space in front of the unit's maintenance hatch and remember to leave the electric wirings easily accessible.
3. If the supply air coil isn't built in, it needs to be connected to the duct. NOTE! The coil should be installed with the condense drain downwards in a horizontal part of the duct. Attach the duct to the unit with flexible connections. We recommend silencers in the supply and exhaust air ducts. The silencer should be installed after the supply air coil.
4. Connect a pipe between the drain outlet and the nearest floor drain or water trap of a sink (min. water column 60 mm). Connecting the unit directly into the sewage system is not allowed.

Installation of the outside unit:

The outside unit is installed outside on a max. distance of 20 m and on a max height difference of 10 m from the coil. There are no special requirements regarding the placement of the outside unit because the outside air temperature doesn't vary much depending on the place of installation. The outside air unit should be mounted steadily to avoid resonance. If the outside air unit i.e. is mounted on a boarded wall it should be equipped with proper absorbing rubber pads to avoid resonance. The unit should not be mounted on the wall outside the bedroom, because it is hard to get rid of all resonance. We recommend that a rack be built for the unit so it doesn't have to lie close to the wall. It is also possible to build an open cover for the unit as long as it doesn't disturb the air flow. The unit is not to be mounted in a closed space. The unit must be mounted high enough to prevent snow from blocking the air flow in wintertime.

Piping and electrical wiring:

Enervent eco EDX is a combination of a ventilation unit and a heat pump. The heat pump is a cooling apparatus. The installation of a cooling apparatus requires a license. Installation of cooling apparatus should only be carried out by licensed companies. The pipes between the outside air unit and the supply air coil are not included in the standard delivery.

The outside air unit also requires electrification. We recommend that the heat pump have its own output on the switchboard. Electrical installations as the installation of cooling apparatus, requires a license. Some companies employ both electricians and installers of cooling apparatus. The cable between the outside unit and ventilation unit is not included in the delivery.

DUCT HEAT INSULATION

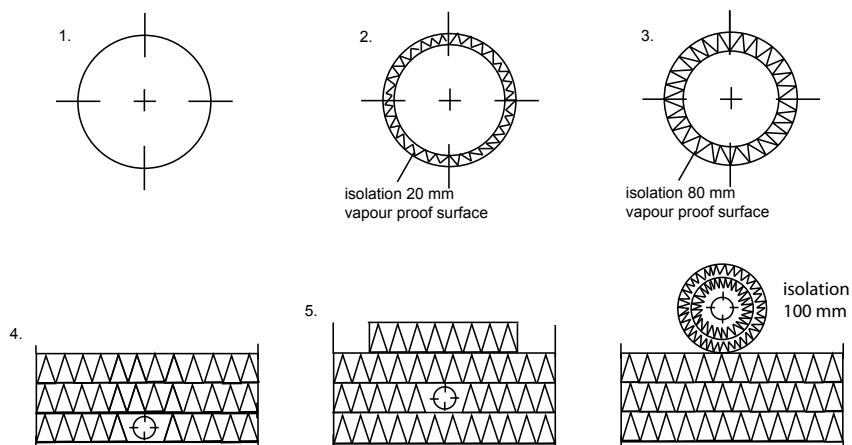

Examples of different insulation alternatives:

1. Exhaust air duct in warm spacing (indoors, no insulation).
2. Supply air duct between ventilation unit and terminal equipment.
3. Waste air and outside air duct in warm spacing (indoors).
4. Exhaust air duct in the ceiling insulation.
5. All ducts in a cold attic. Outside air and waste air ducts must not be assembled directly above the steam barrier. Both ducts require an insulation layer of 100 mm thick mineral wool.

STARTING THE SYSTEM

The Enervent eco EDX system can be started when the following installations have been made:

- The ventilation unit is installed.
- The supply air coil is installed, if it is a duct coil.
- The electrical duct heater is installed.
- The outside unit is mounted.
- The piping between the outside unit and the coil is done.
- The refrigerant circuit is evacuated and filled.
- The draining of condense water is connected through a water lock.
- The ducts with silencers are connected to the ventilation unit.
- The terminal equipments are installed.
- An outside air grille has been mounted on the fresh air intake (NOTE! Do not put an insect net on the fresh air intake because it blocks up very easily).
- Make the roof pass-through. We recommend the use of a factory made, insulated roof pass-through.
- The ducts has been insulated as instructed.
- The ventiation unit and the outside unit have been provided with the appropriate power supply and the control cable has been connected.
- Connect the control panel to the unit (mother board plug OP1) with the cable provided.
- The air flows have been regulated.
- PYR4 is set to the right value. Detailed instructions on page 28.

Open the unit's maintenance hatch when all the above mentioned installation work is done. Check that the unit is clean on the inside, that there are no spare parts inside it and that the filters are clean. Close the maintenance hatch carefully. NOTE! The unit should not be run with the hatch open. The EDX unit is started by connecting the current to the unit. In this mode both the fans and the rotating heat exchanger run.

SPECIAL FEATURES OF THE EDX SYSTEM

Frost over and freezing

The EDX system's outside unit might frost over and freeze during the winter. Snow might also accumulate on the outside unit during blizzards. This is completely normal and it doesn't affect the outside unit's function. The frost over occurs because the refrigerant evaporates in the outside unit during heating mode. This causes the lamella surfaces in the outside unit to cool down. The humidity in the outside air freezes when it comes in contact with these cold surfaces. This is commonly seen as white frost on the outside unit surfaces. The phenomenon is emphasized at temperatures around $\pm 0^{\circ}\text{C}$.

The easiest way to melt a severely frozen outside unit is to pour warm water over it. It allows the ice to melt without harming the outside unit. The ice must not be removed by hitting with a chisel or such. Cut the power to the outside unit before attempting to melt it!

An ice pile gathers beneath the outside unit due to the melting water. It can be removed as needed. **NOTE!** If the space between the outside unit and the surface beneath it is small, the ice gathering under the outside unit might lift it of its place. If the space is small, the ice must be removed often. We recommend that 40 cm free space is left under the outside unit.

EDX COIL HEATING AND COOLING CAPACITY

Pingvin EDX - coil heating and cooling capacity (ΔT)

Heat pump RP-35
Cooling media R-410A
Duct mounted coil 1007182

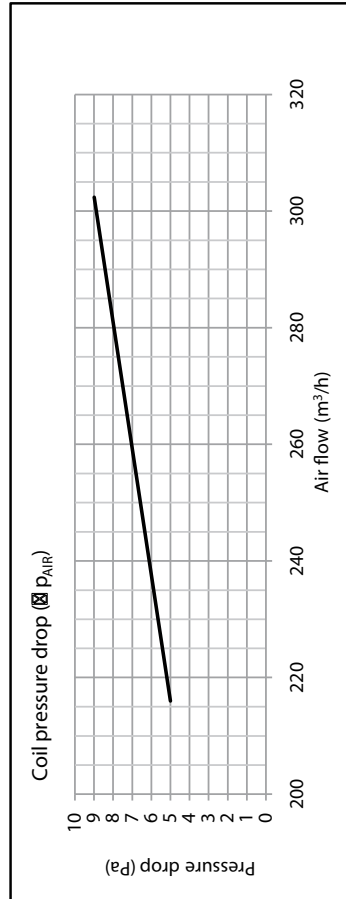
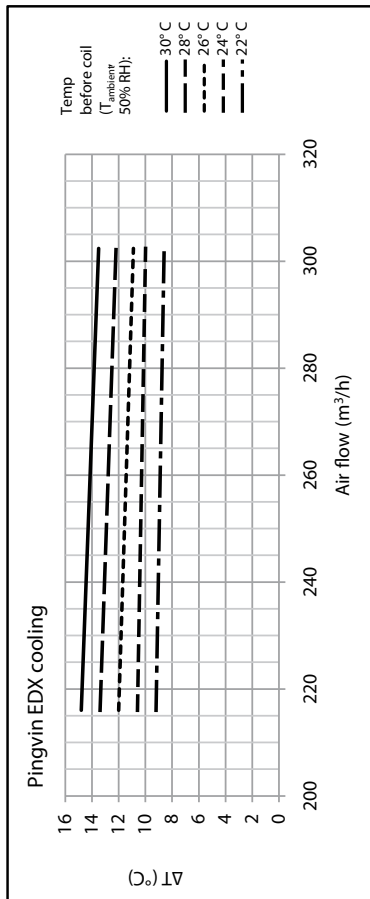
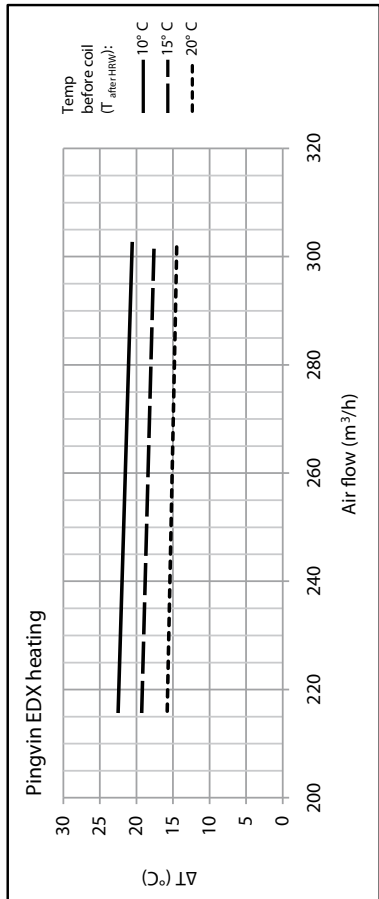

Pingvin EDX coil heating and cooling capacity (kW)

Heat pump RP-35
Cooling media R-410A
Duct mounted coil 1007182

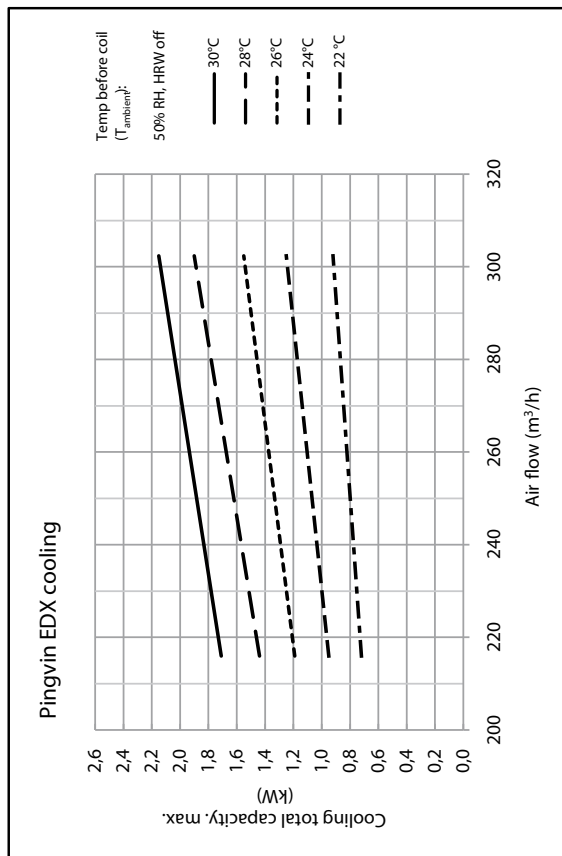
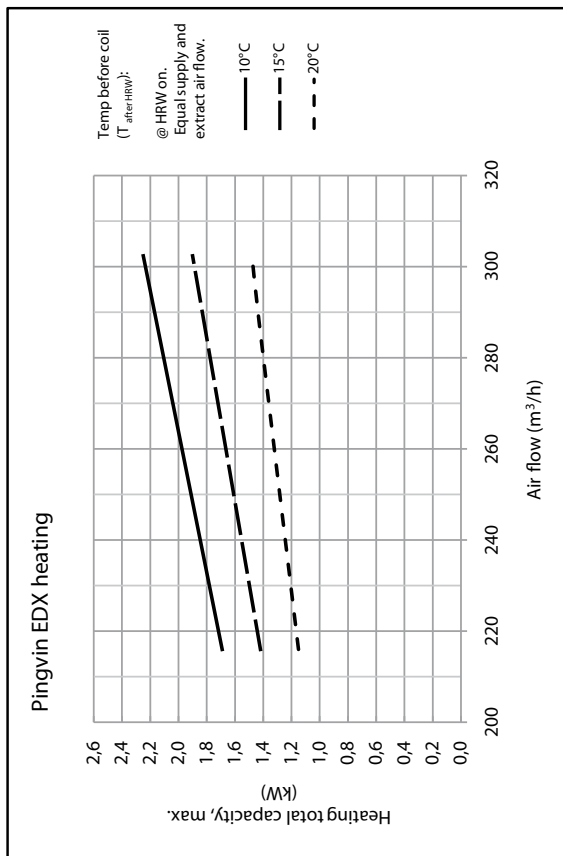

Pandion EDX coil heating and cooling capacity (kW)

Heat pump RP-35
Cooling media R-410A
Coil integrated in AHU 1007156
Duct mounted coil 1007182

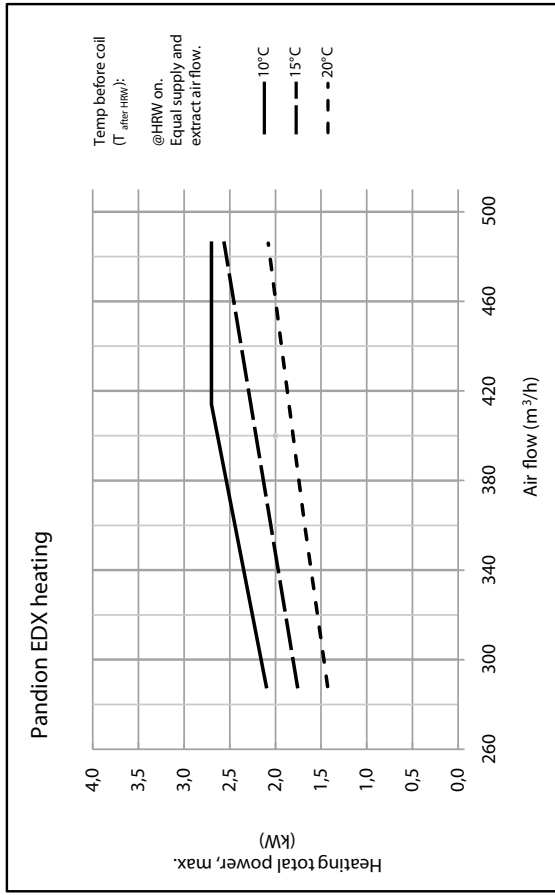

Pandion EDX - coil heating and cooling capacity (ΔT)

Heat pump RP-35
Cooling media R-410A
Coil integrated in AHU 1007156
Duct mounted coil 1007182

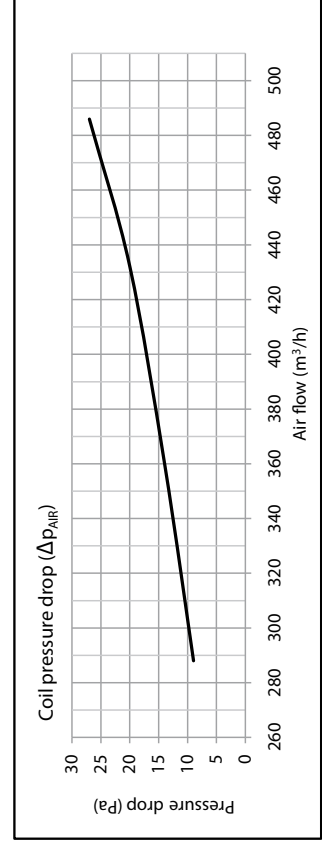
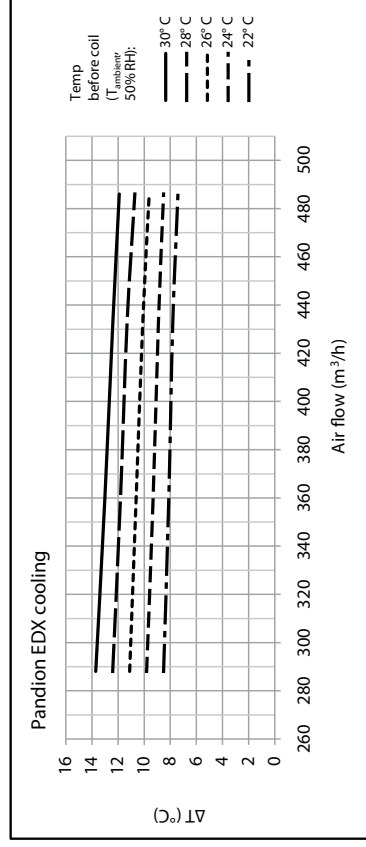
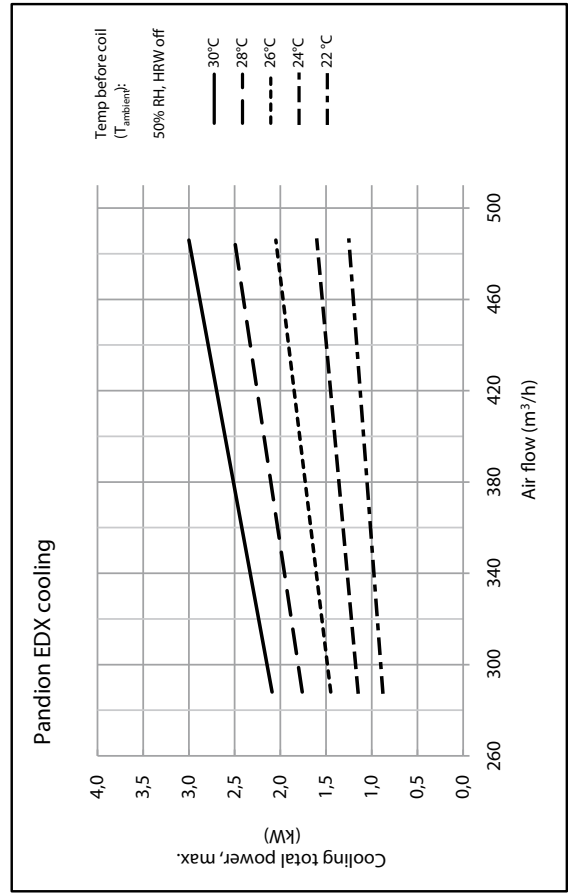
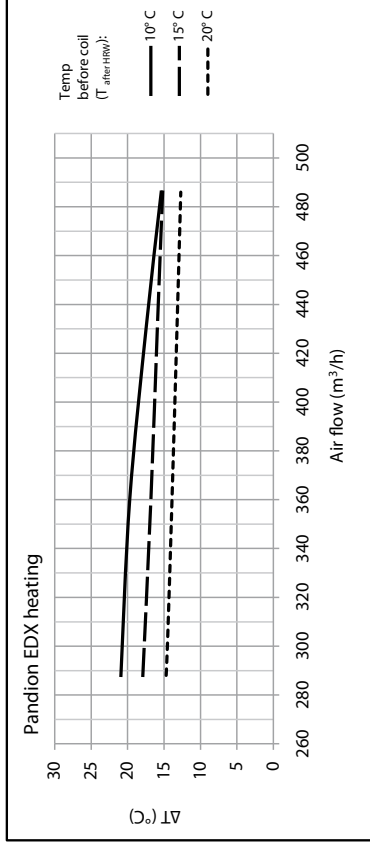

Pelican EDX coil heating and cooling capacity (kW)

Heat pump RP-35
Cooling media R-410A
Coil integrated in AHU 1007286

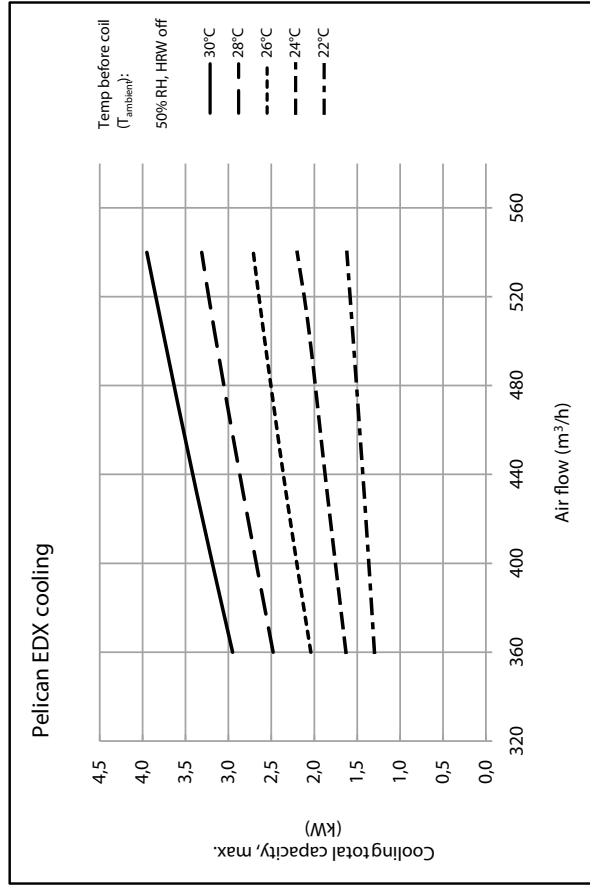
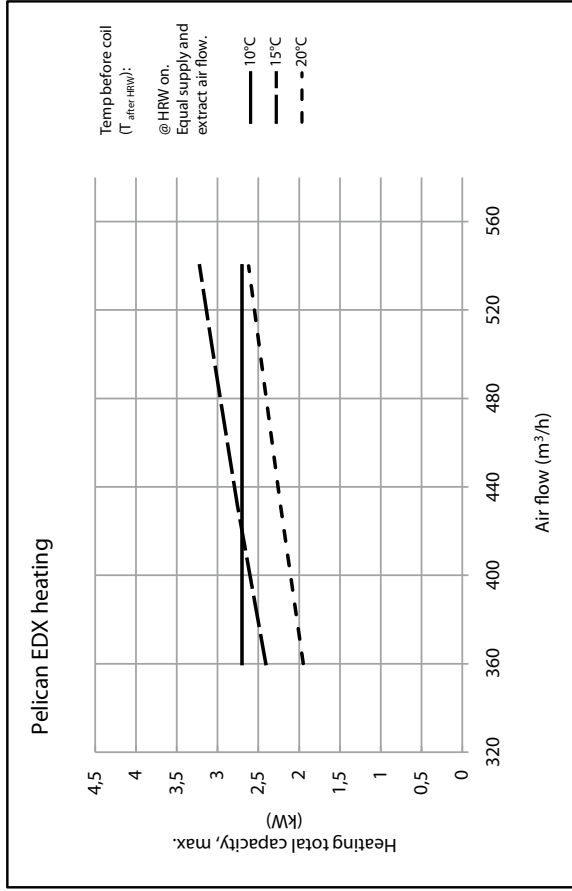

Pelican EDX coil heating and cooling capacity (ΔT)

Heat pump RP-35
Cooling media R-410A
Coil integrated in AHU 100796

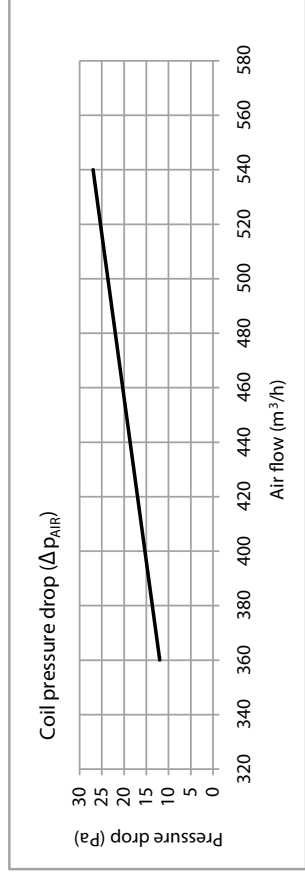
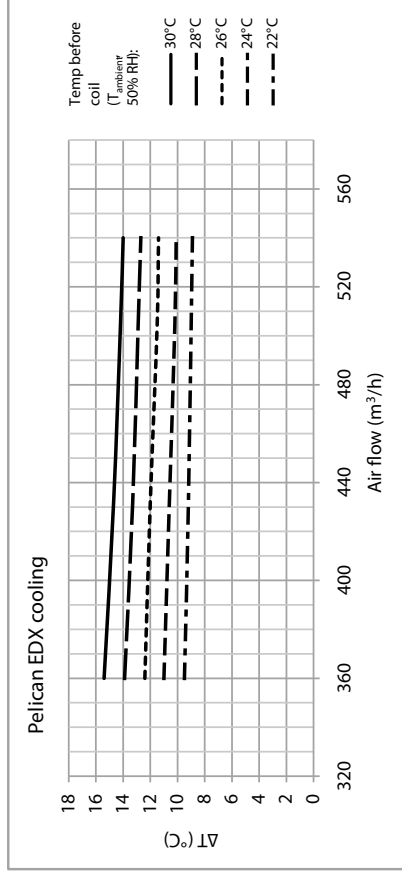
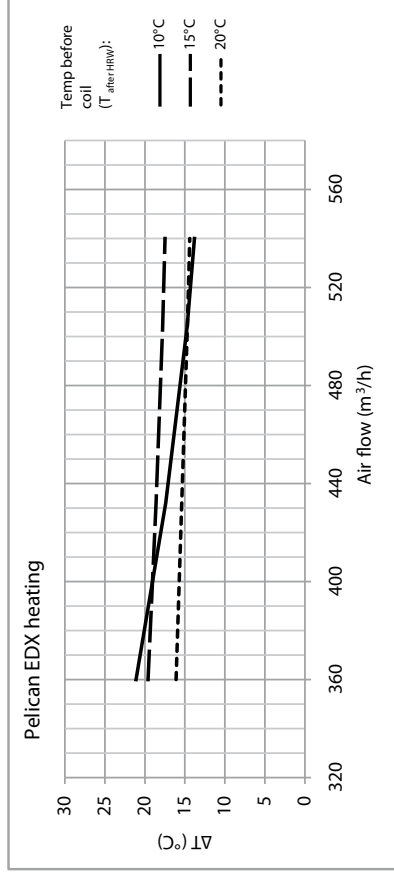

Pegasos EDX coil heating and cooling capacity (kW)

Heat pump RP-50
Cooling media R-410A
Coil integrated in AHU 1007286

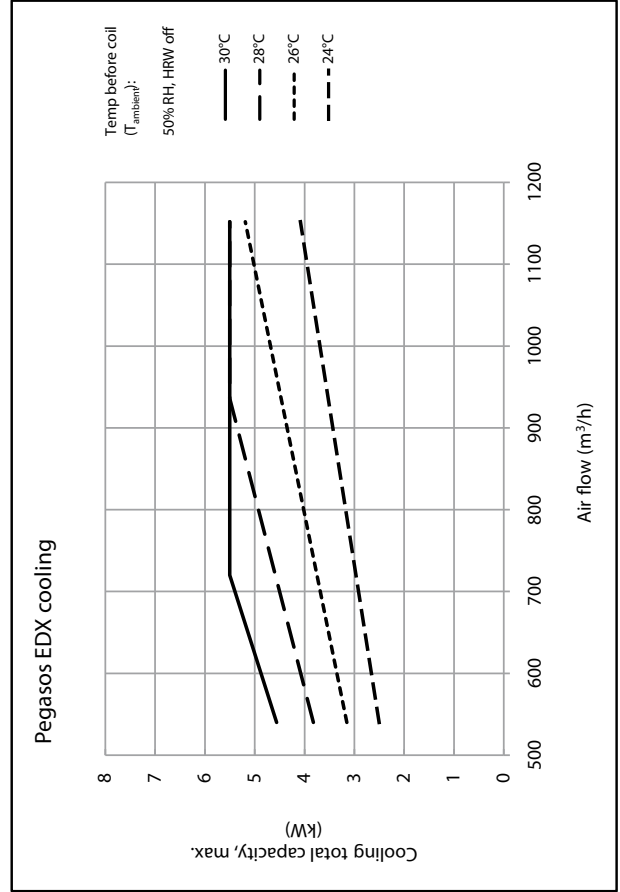
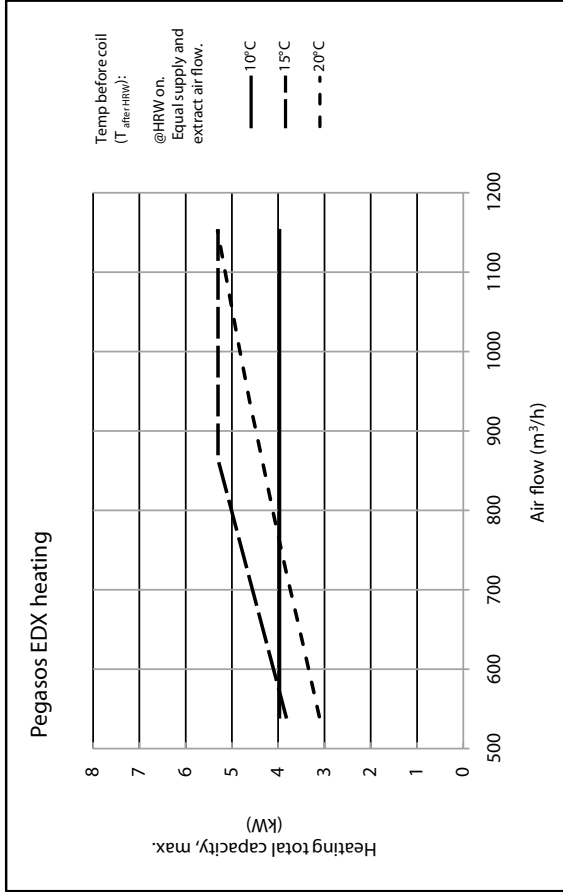

Pegasos EDX coil heating and cooling capacity (ΔT)

Heat pump RP-50
Cooling media R-410A
Coil integrated in AHU 1007286

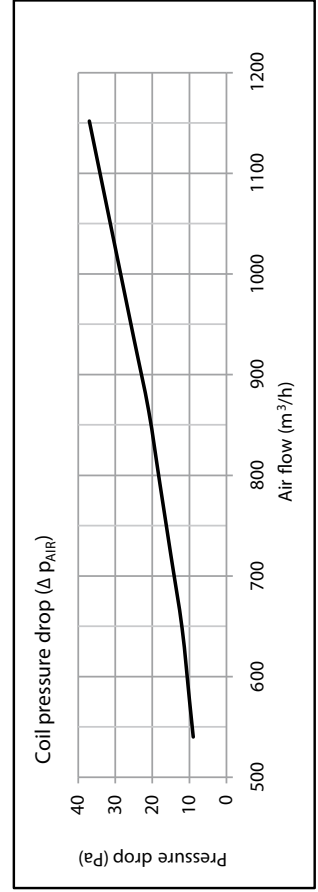
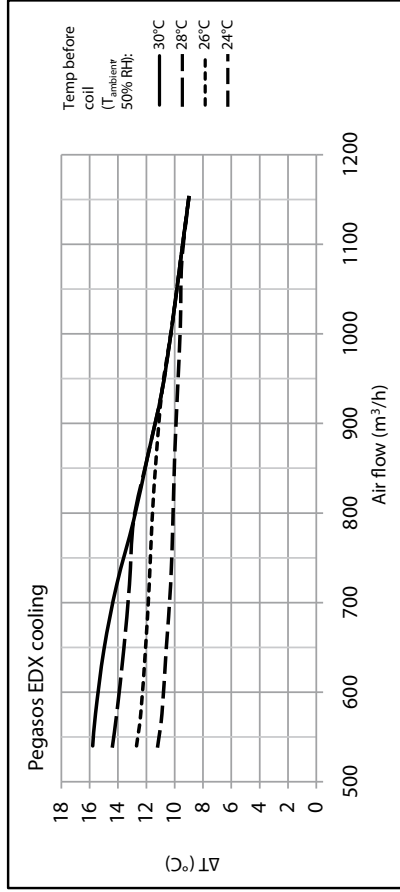
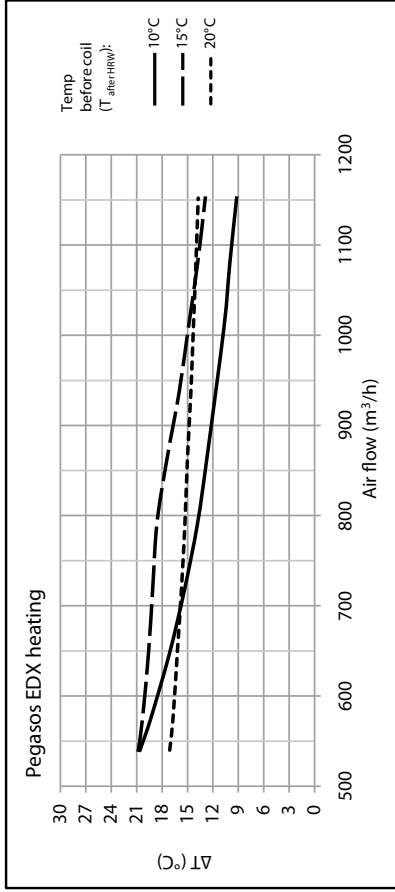

Pegasos EDX coil heating and cooling capacity (kW)

Heat pump RP-60 (option)
Cooling media R-410A
Coil integrated in AHU 1007286

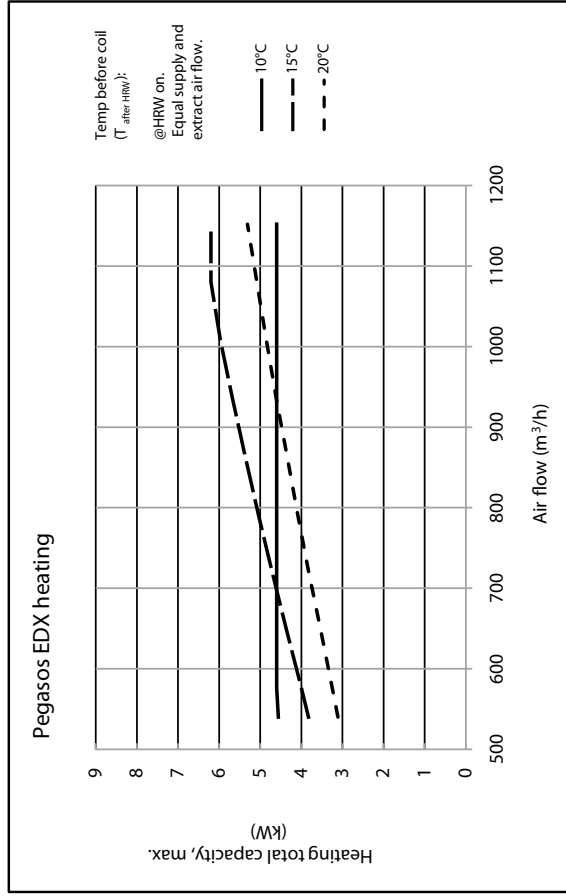

Pegasos EDX - coil heating and cooling capacity (ΔT)

Heat pump RP-60 (option)
Cooling media R-410A
Coil integrated in AHU 1007286

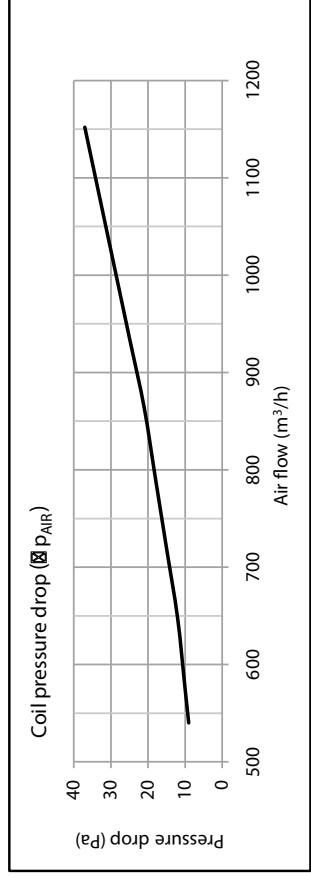
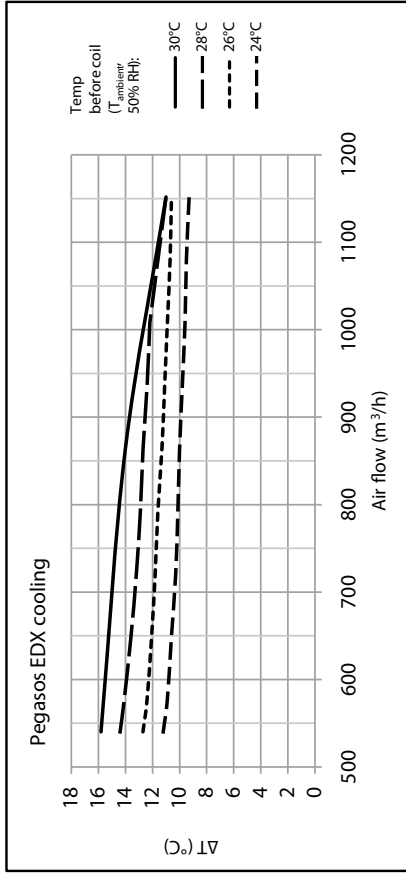
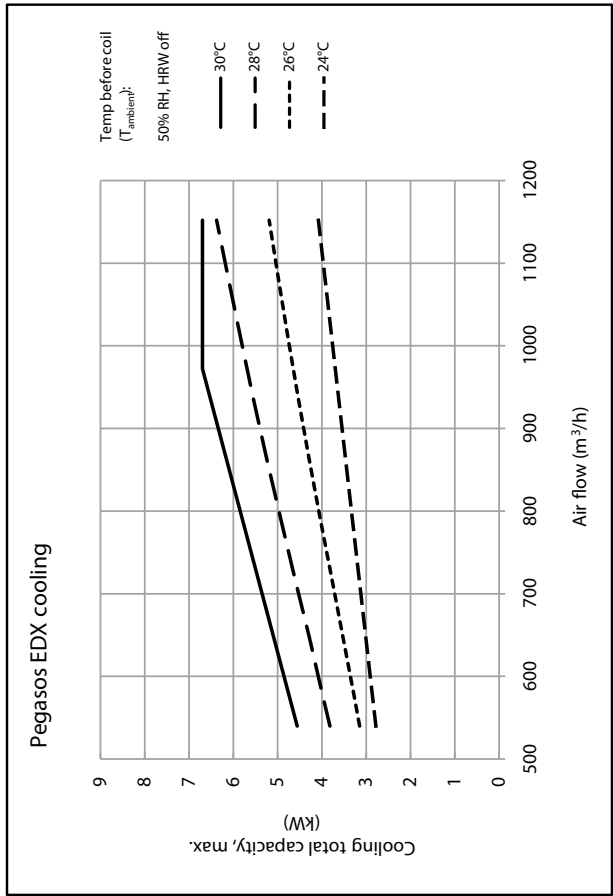
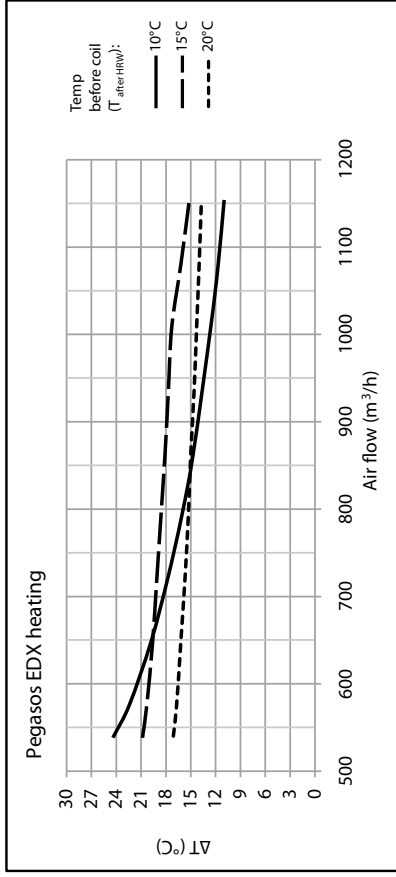

Pegasos XL EDX coil heating and cooling capacity (ΔT)

Heat pump RP-60
Cooling media R-410A
Duct mounted coil 1007521

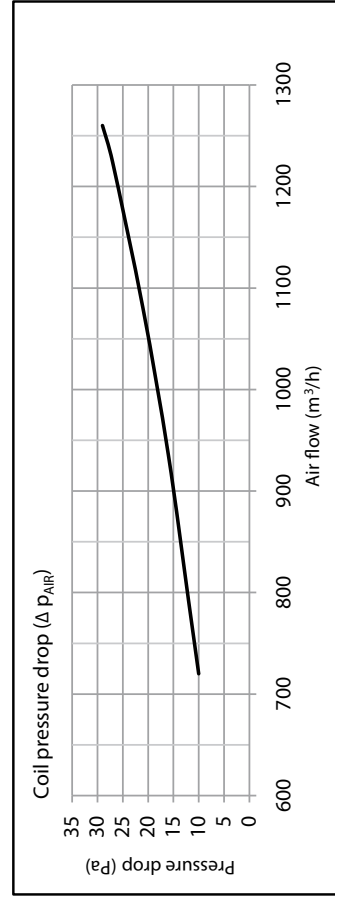
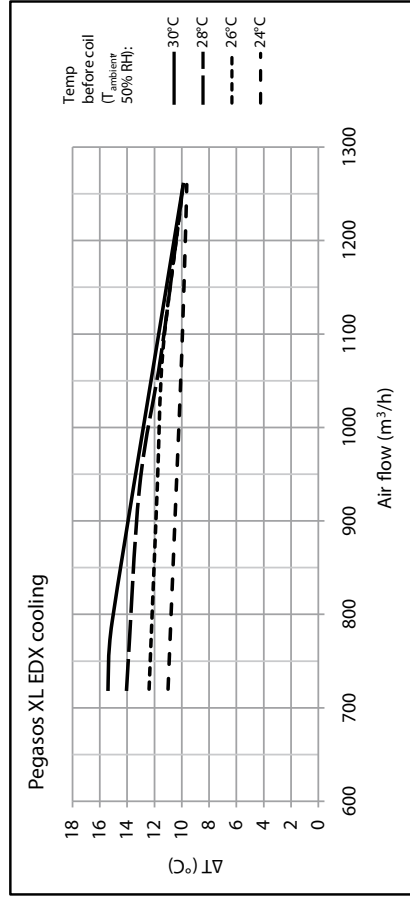
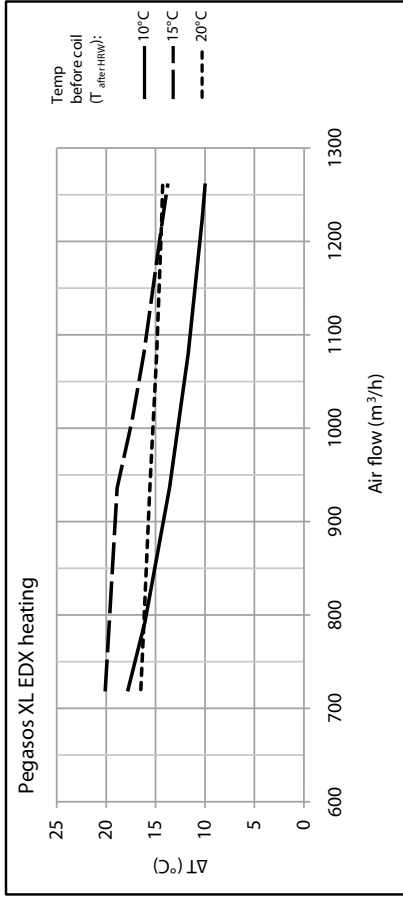

Pegasos XL EDX coil heating and cooling capacity (kW)

Heat pump RP-60
Cooling media R-410A
Duct mounted coil 1007521

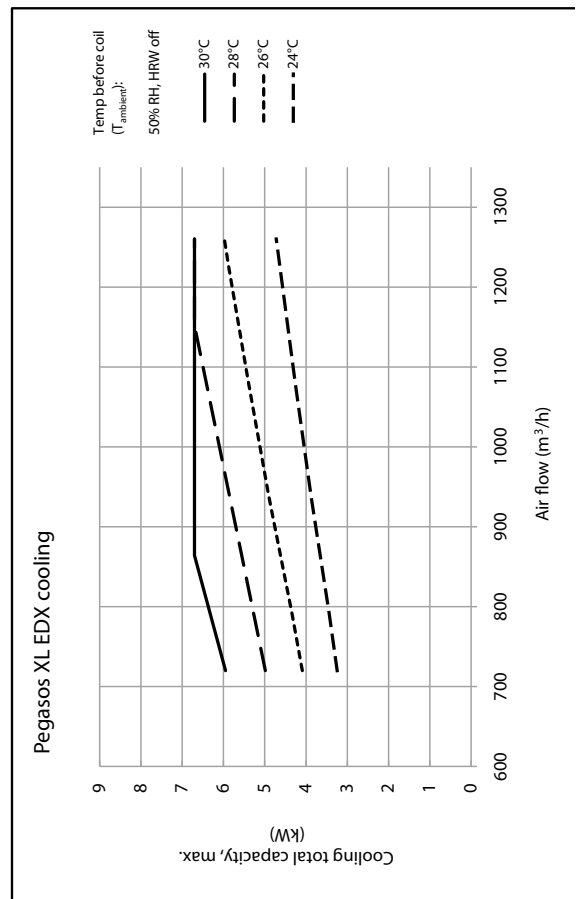
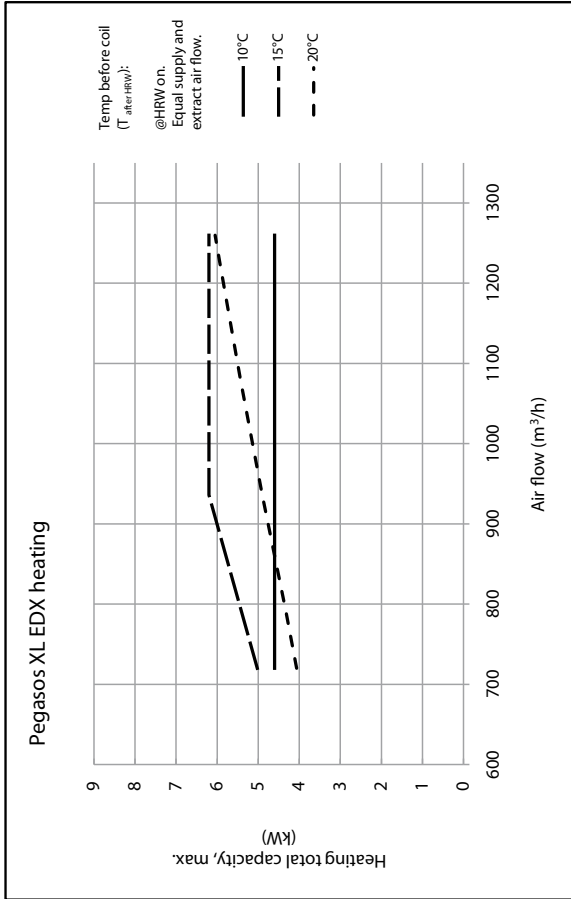

Pegasos XL EDX - coil heating and cooling capacity (ΔT)

Heat pump RP-71 (option)
Cooling media R-410A
Duct mounted coil 1007521

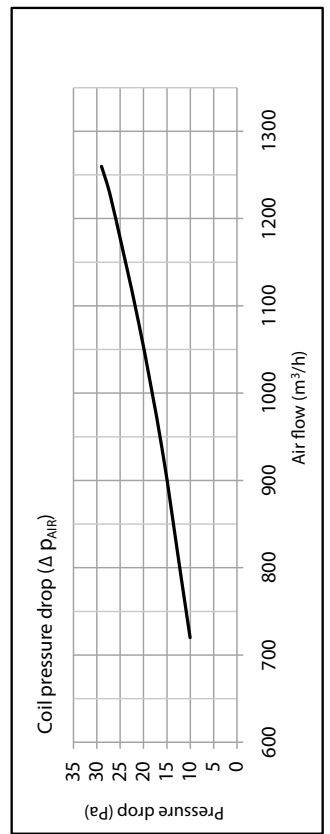
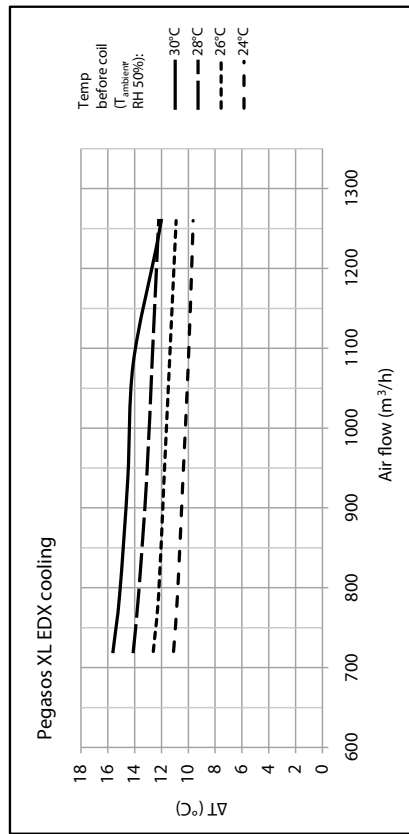
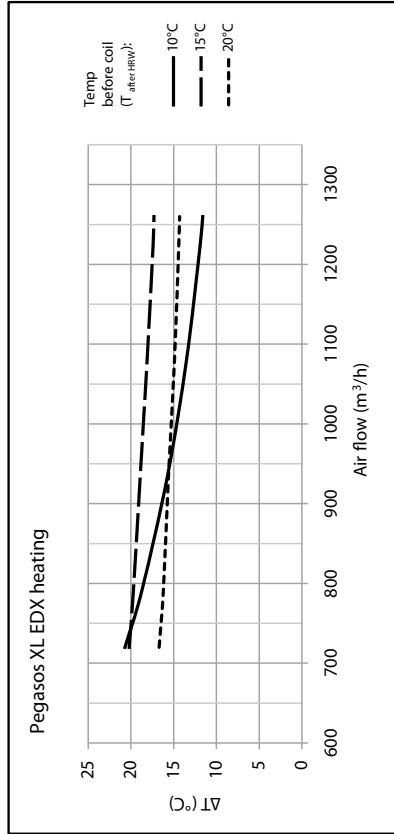

Pegasos XL EDX coil heating and cooling capacity (kW)

Heat pump RP-71 (option)
Cooling media R-410A
Duct mounted coil 1007521

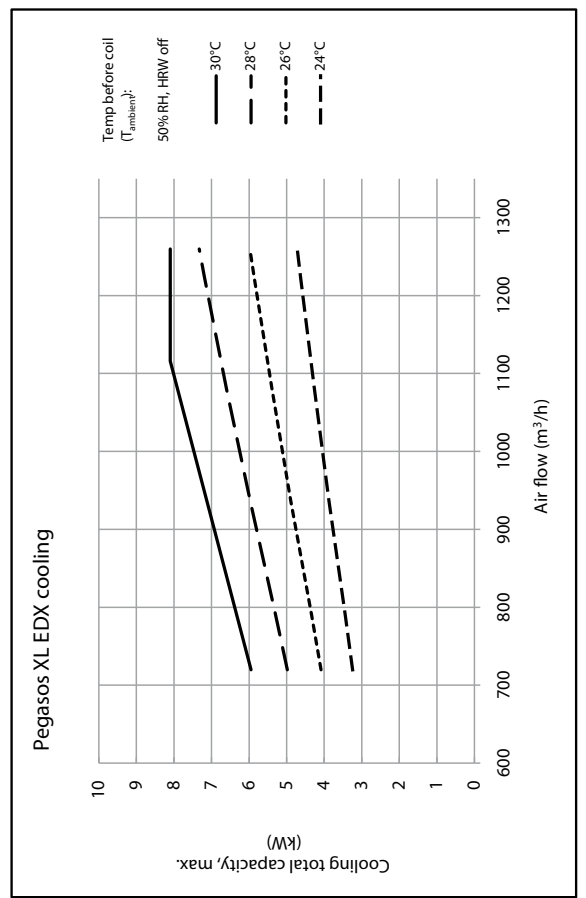
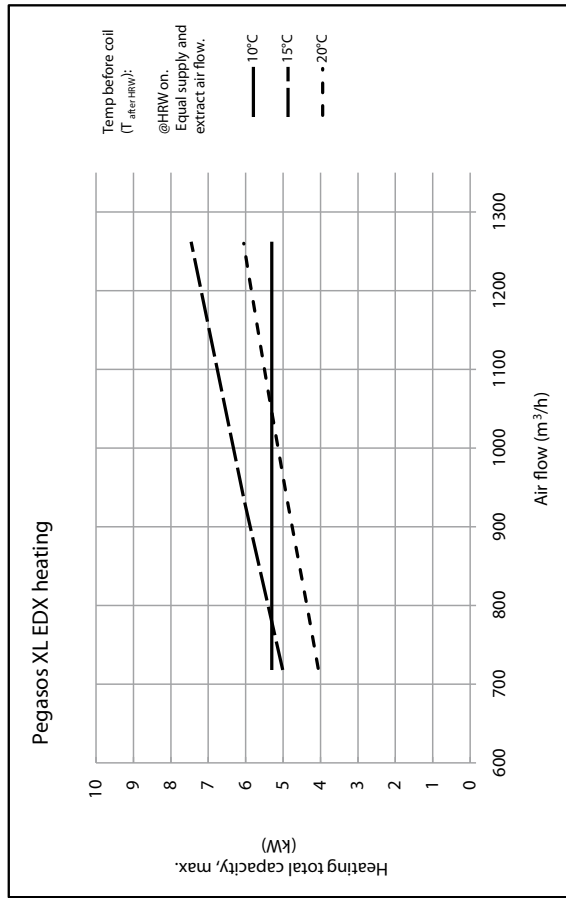

LTR-3 EDX coil heating and cooling capacity (kW)

Heat pump RP-35
Cooling media R-410A
Duct mounted coil 1007182

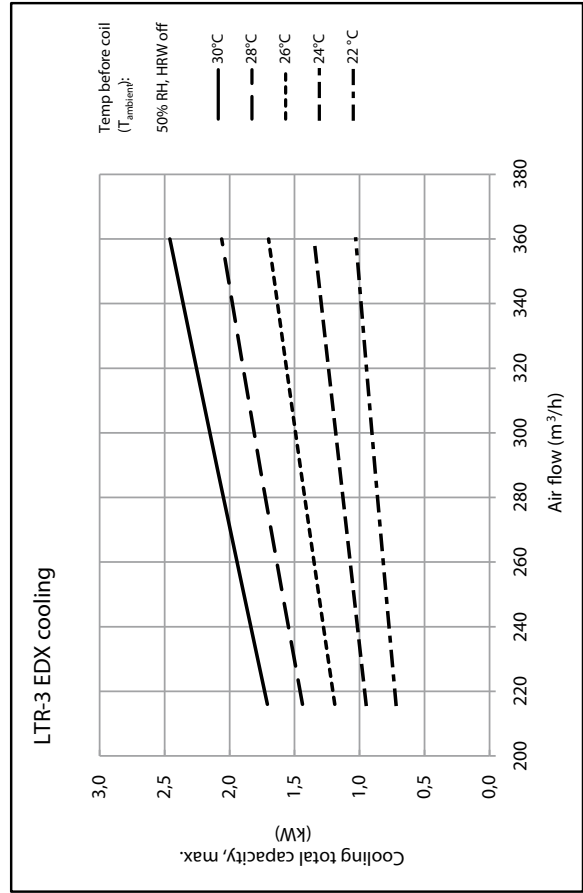
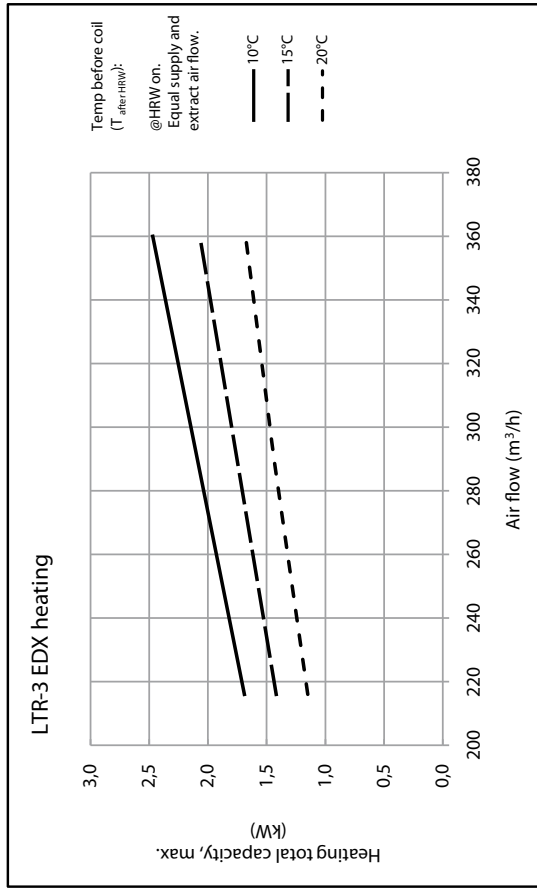

LTR-3 EDX coil heating and cooling capacity (ΔT)

Heat pump RP-35
Cooling media R-410A
Duct mounted coil 1007182

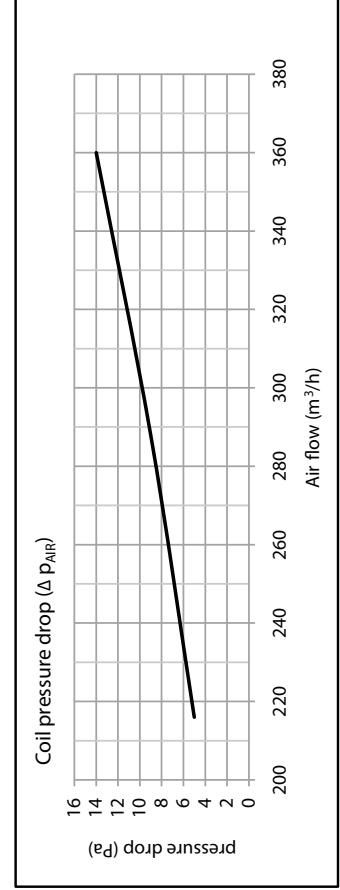
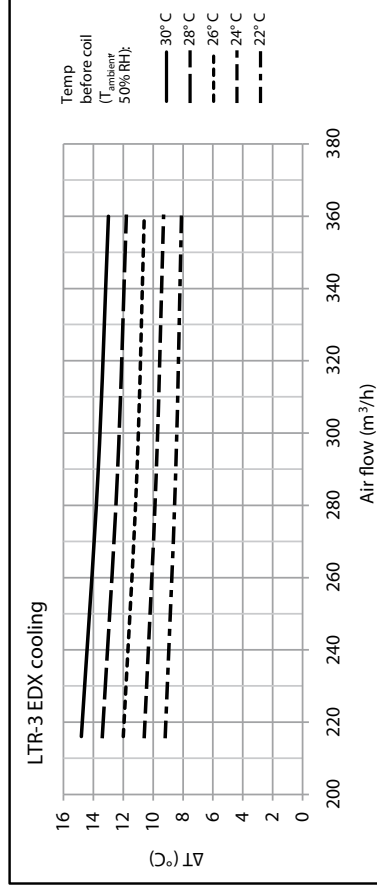
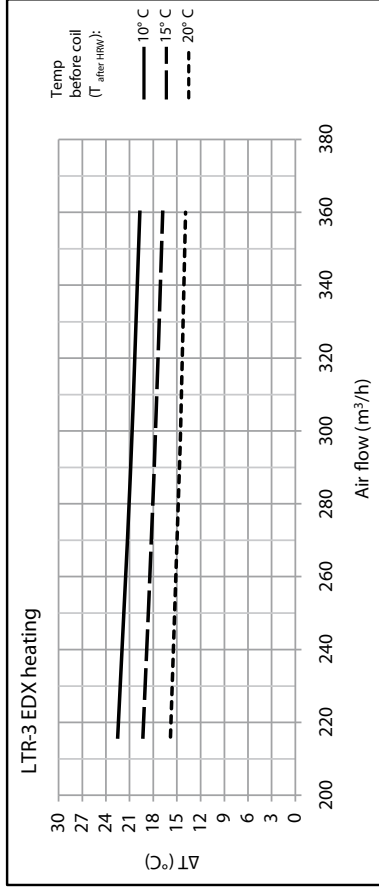

LTR-6 EDX coil heating and cooling capacity (kW)

Heat pump **RP-35**
 Cooling media **R-410A**
 Coil integrated in AHU **100711**
 Duct mounted coil **1007139**

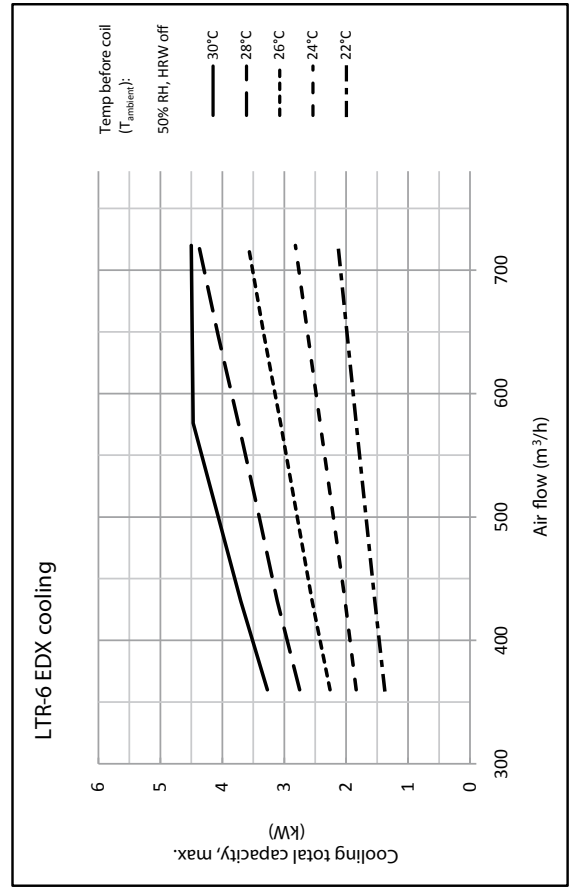
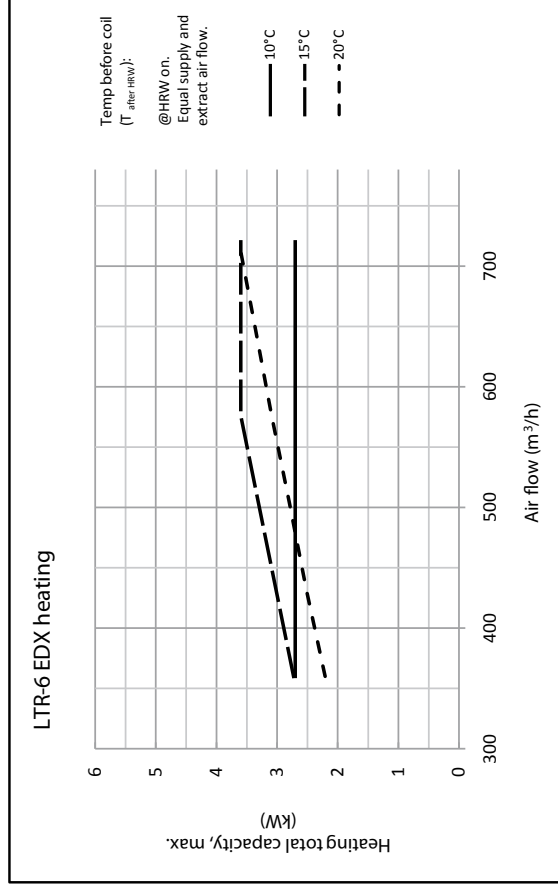

LTR-6 EDX coil heating and cooling capacity (ΔT)

Heat pump **RP-35**
 Cooling media **R-410A**
 Coil integrated in AHU **100711**
 Duct mounted coil **1007139**

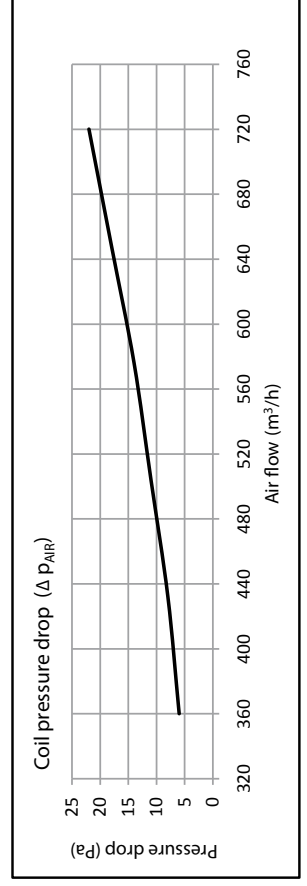
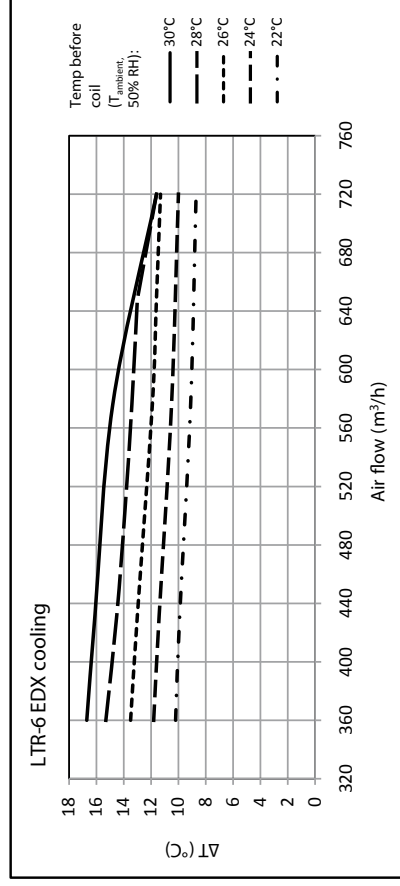
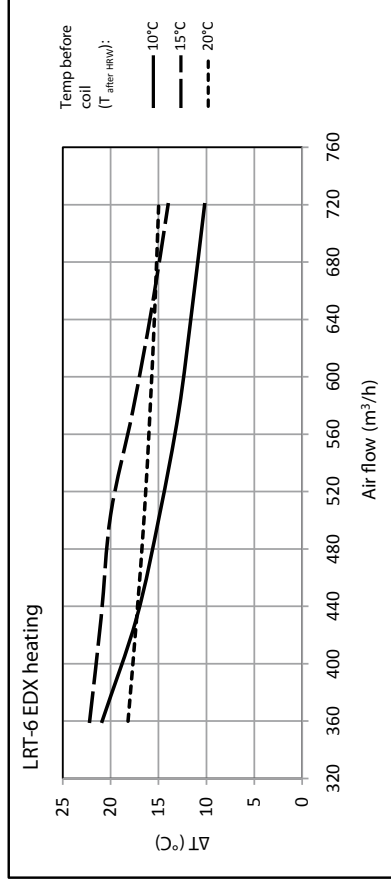

LTR-7 EDX coil heating and cooling capacity (kW)

Heat pump RP-50
Cooling media R-410A
Duct mounted coil 1007286

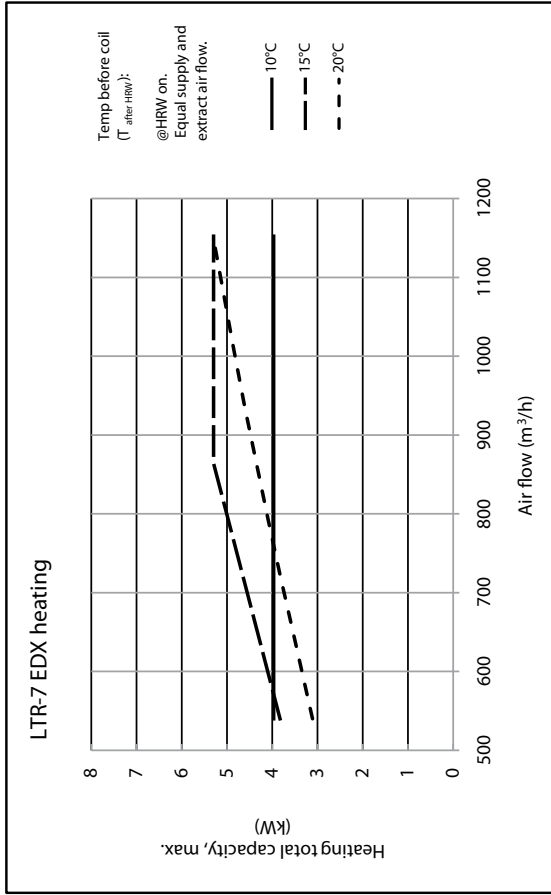

LTR-7 EDX coil heating and cooling capacity (ΔT)

Heat pump RP-50
Cooling media R-410A
Duct mounted coil 1007286

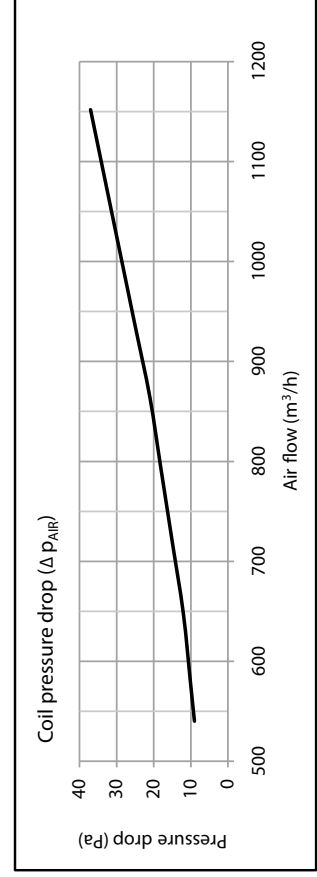
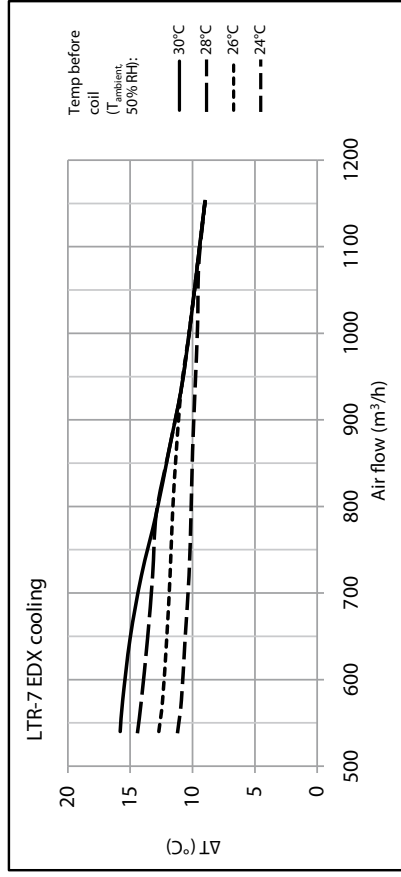
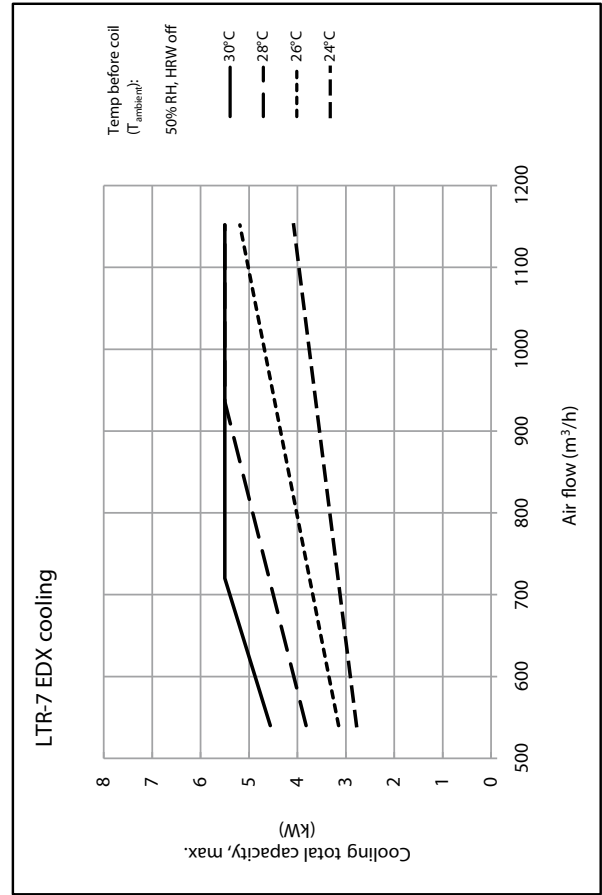
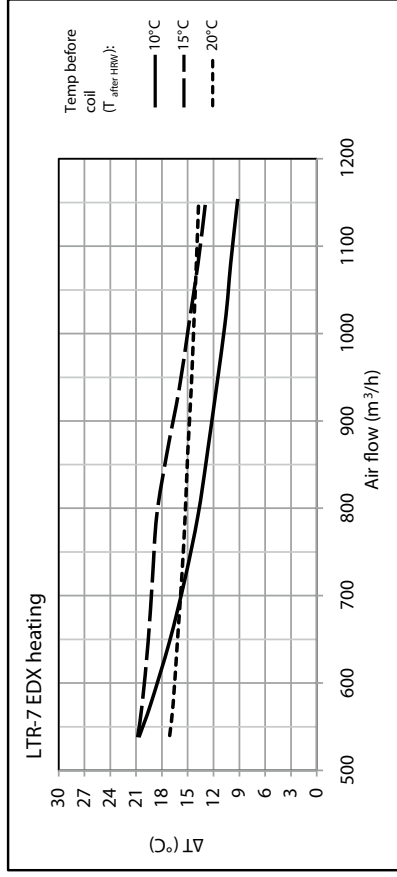

LTR-7 EDX coil heating and cooling capacity (ΔT)

Heat pump RP-60 (option)
Cooling media R-410A
Duct mounted coil 1007286

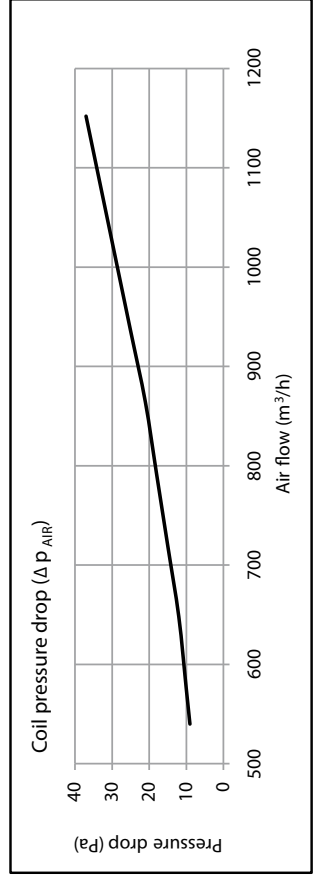
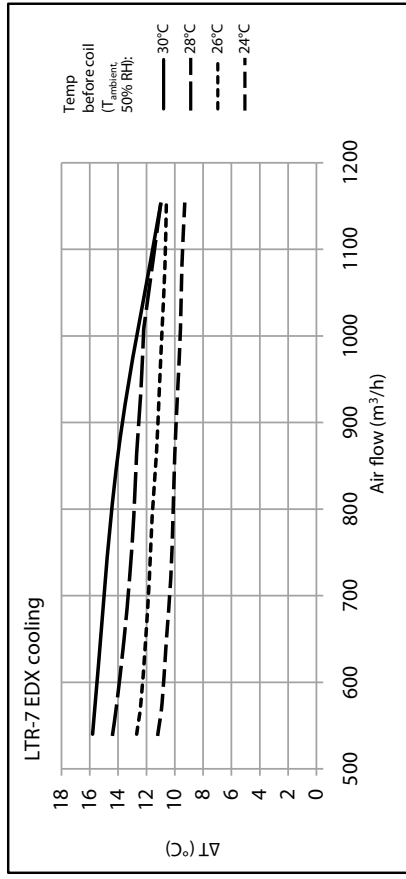
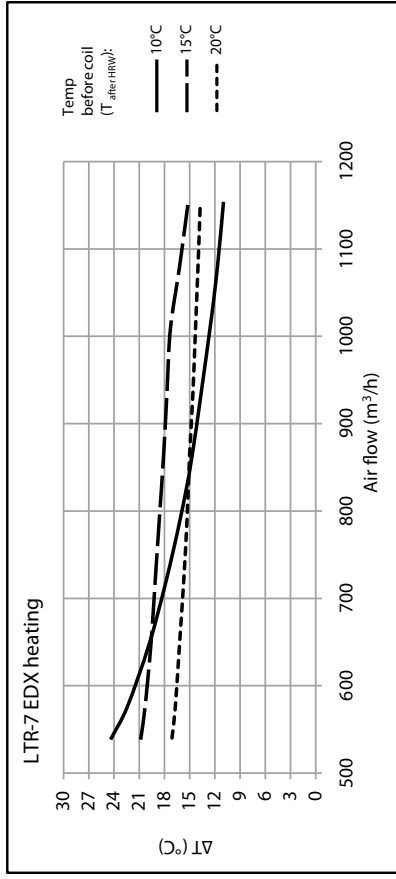

LTR-7 EDX coil heating and cooling capacity (kW)

Heat pump RP-60 (option)
Cooling media R-410A
Duct mounted coil 1007286

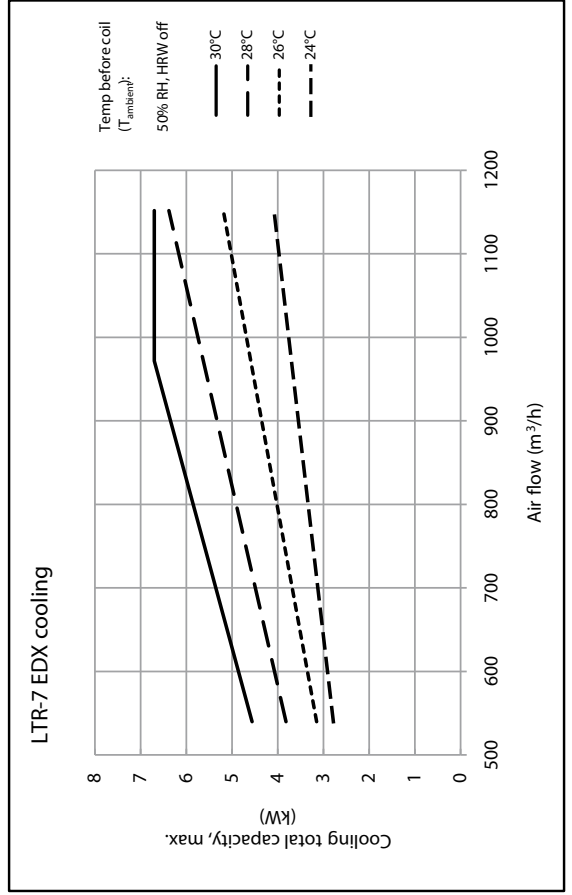
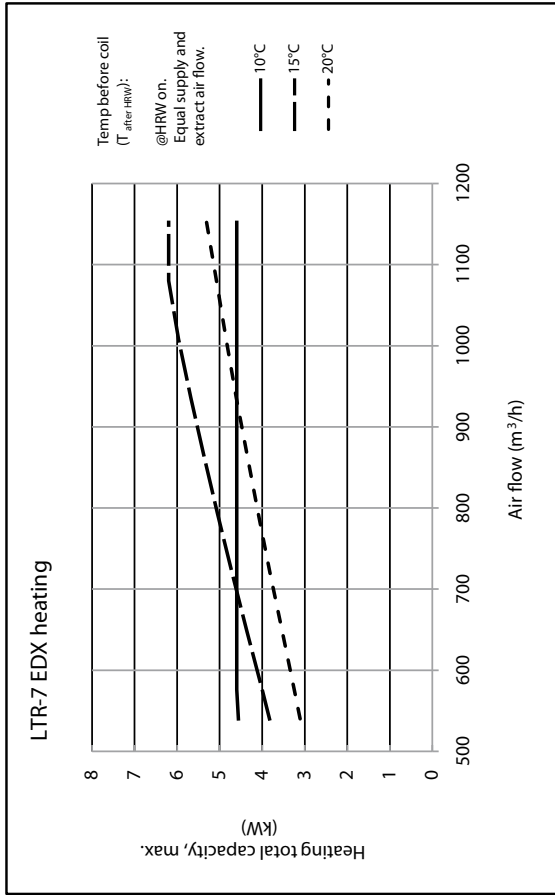

LTR-7 XL EDX - coil heating and cooling capacity (ΔT)

Heat pump RP-60
Cooling media R-410A
Duct mounted coil 1007521

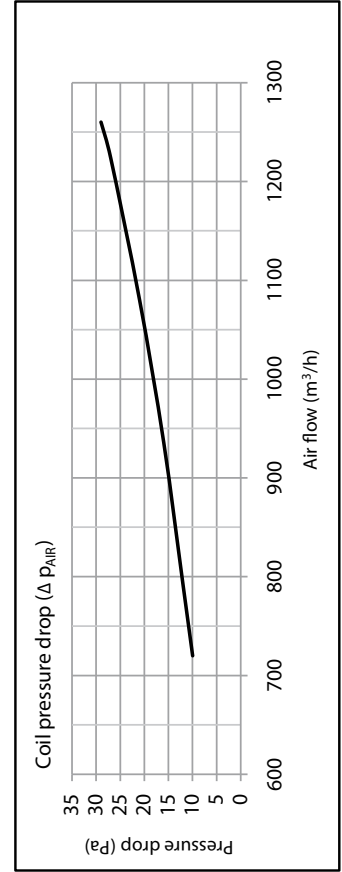
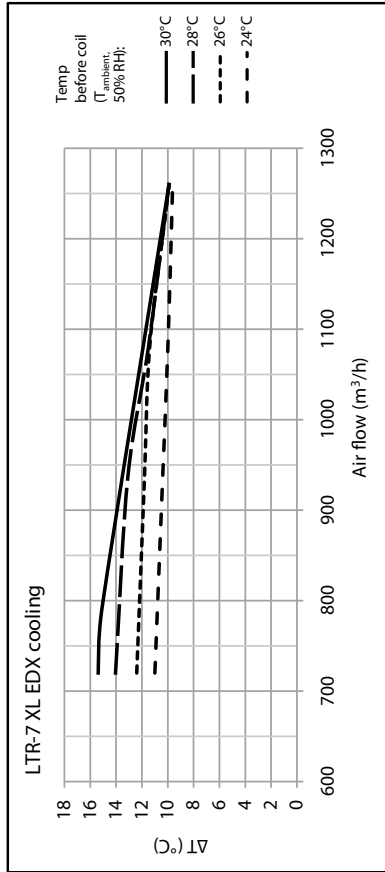
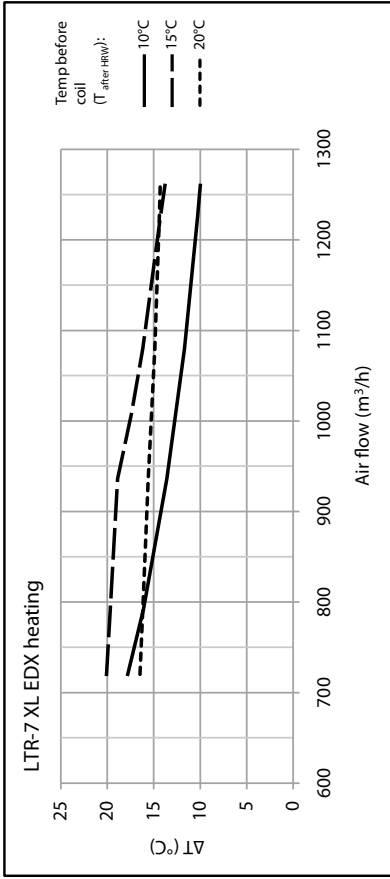

LTR-7 XL EDX coil heating and cooling capacity (kW)

Heat pump RP-60
Cooling media R-410A
Duct mounted coil 1007521

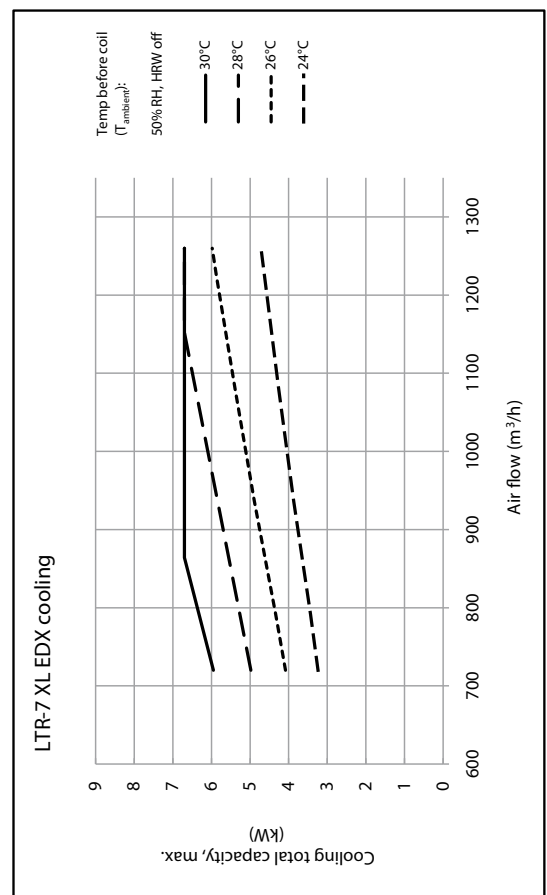
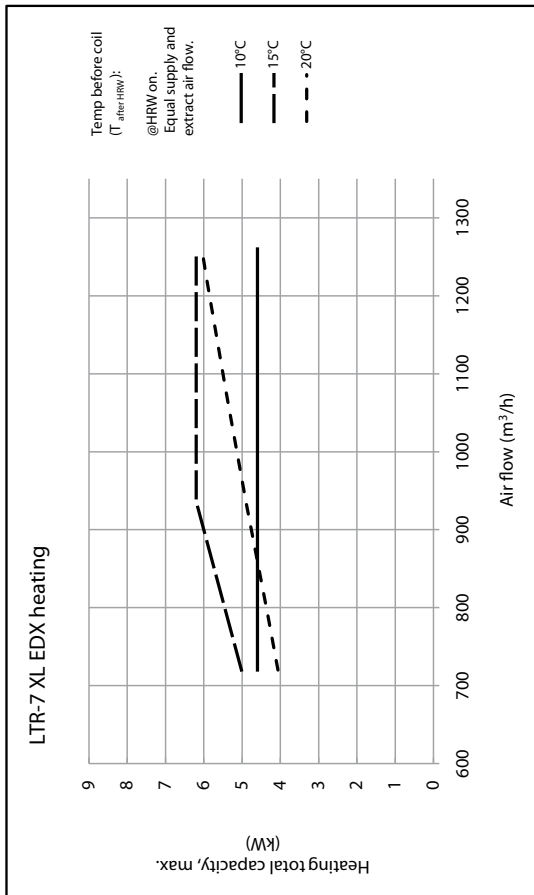

LTR-7 XL EDX coil heating and cooling capacity (ΔT)

Heat pump RP-71 (option)
Cooling media R-410A
Duct mounted coil 1007521

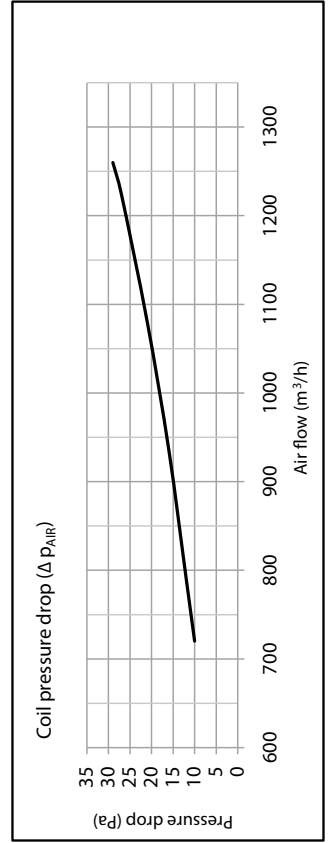
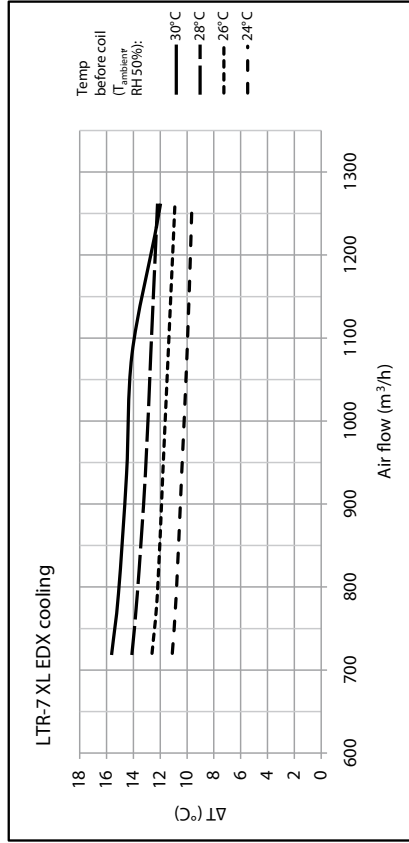
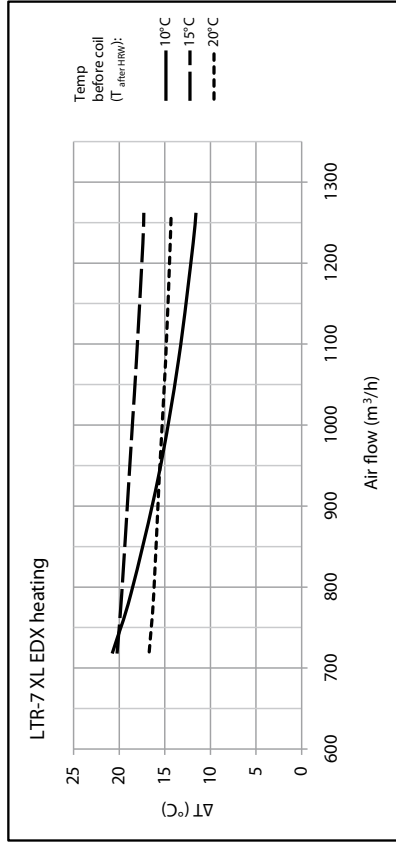

LTR-7 XL EDX coil heating and cooling capacity (kW)

Heat pump RP-71 (option)
Cooling media R-410A
Duct mounted coil 1007521

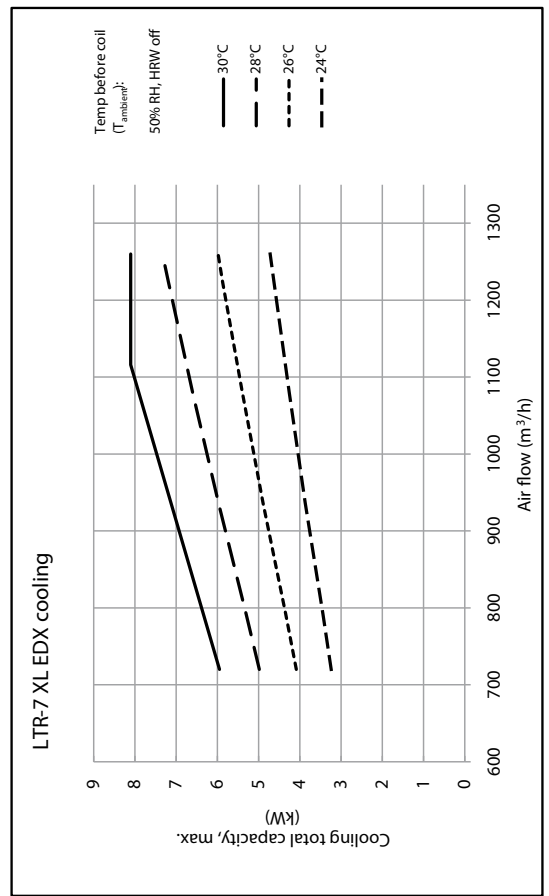
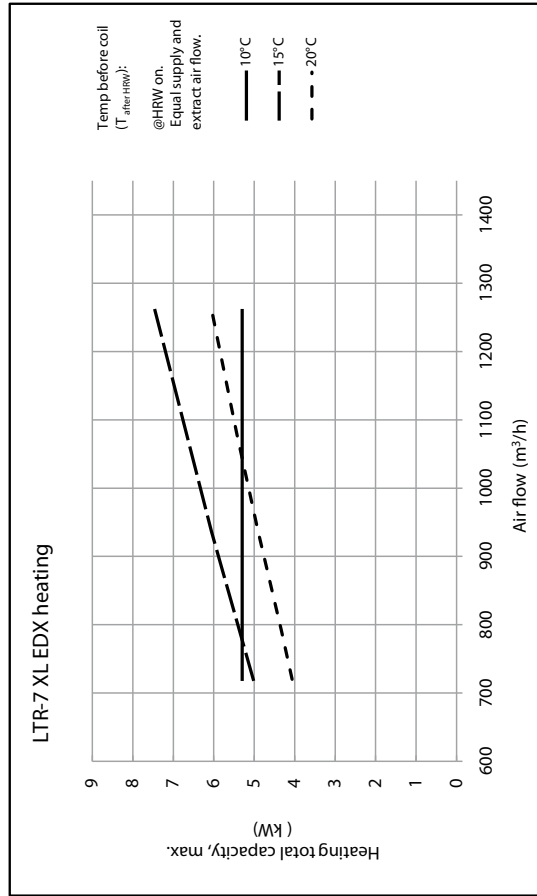

WIRING DIAGRAM eco EDX-E

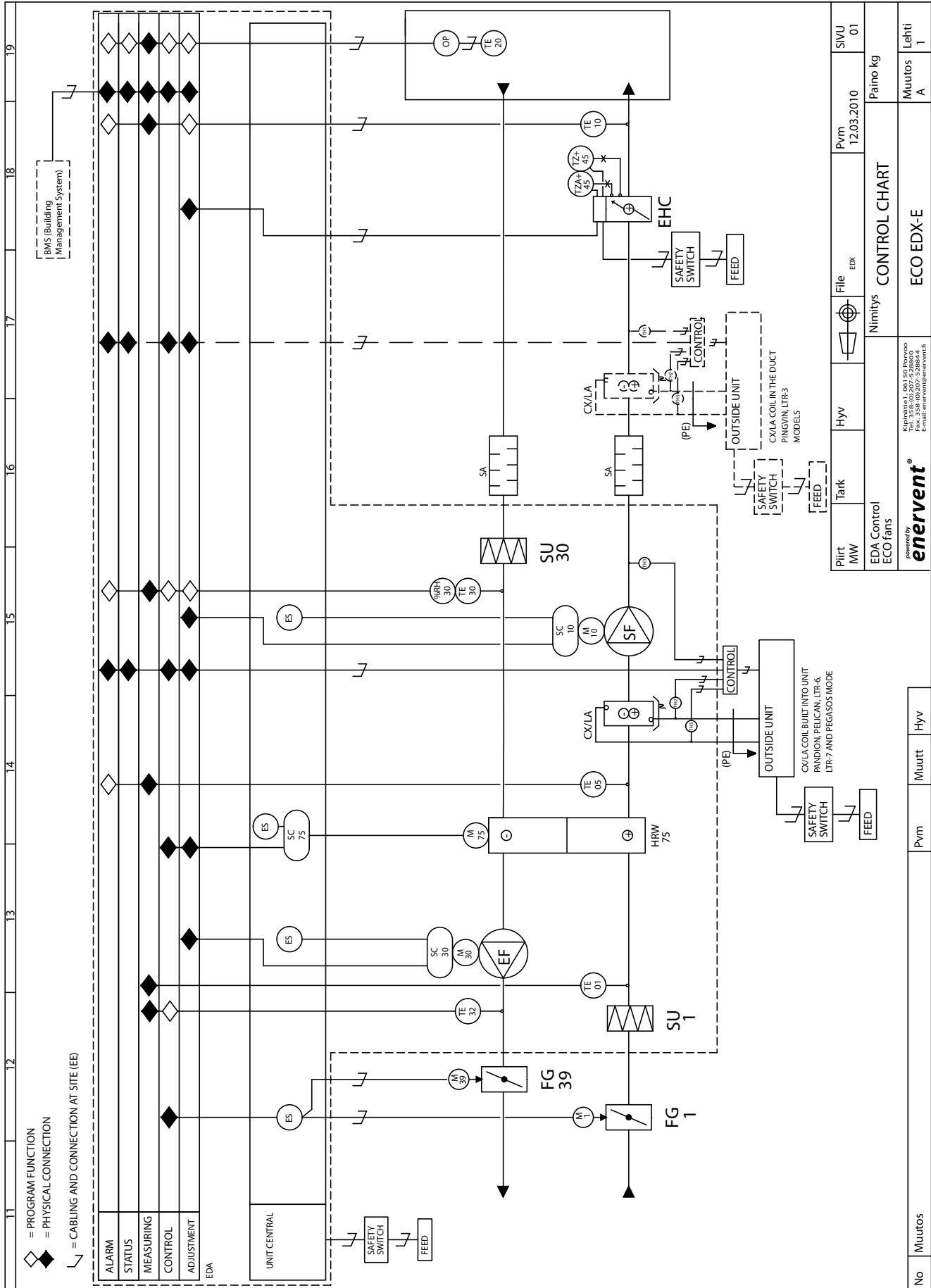

No	Muutos	Pvm	Muutt	Hyv	Tark	Hyv	File	Pvm	SWU
							EDX	12.03.2010	01
EDA Control ECO fans		Nimitys		CONTROL CHART		ECO EDX-E		Paino kg	
powered by enervent		Kipinäkatu, 06010 Porvoo Puh. 3548 00207-228894 E-mail: enervent@enervent.fi		Muutos		Lehti		1	

INTERNAL AND EXTERNAL CONNECTIONS

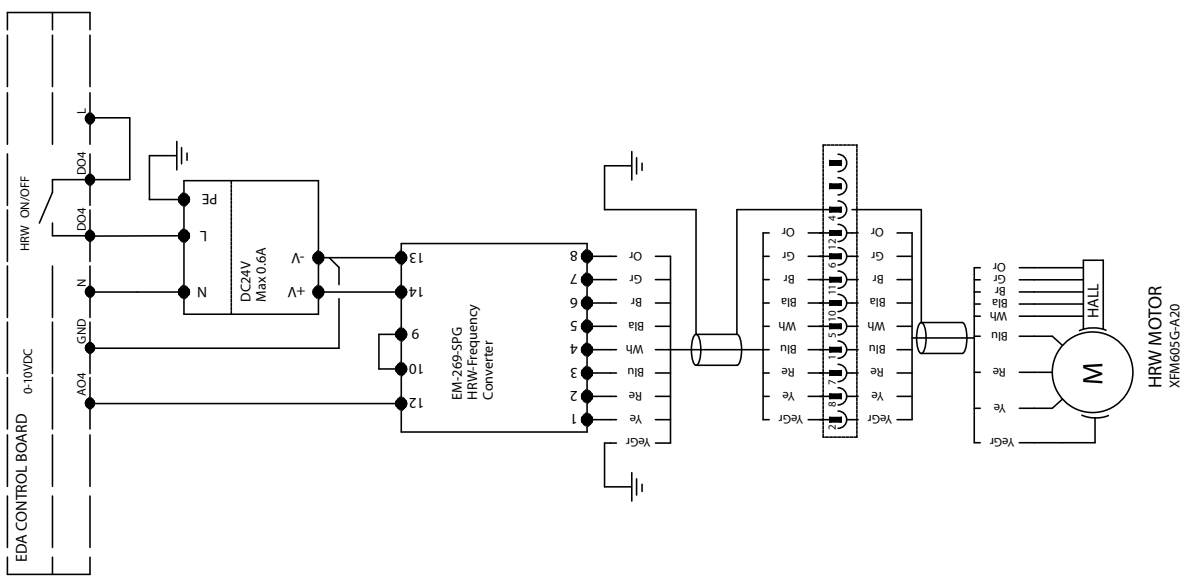

Drawn by: MW	Inspected by:	Appr. by:	File EDX_REV0	Date 08.11.2010	Page 2
Name HRW MOTOR			Name CONNECTION DIAGRAM (EDX)		Weight kg
enervert <small>Kipinäntie 1, 00550 Parvoo Puh: 3558 02307-528944 Fax: 3558 02307-528944 E-mail: enervert@enervert.fi</small>			Name INTERNAL CONNECTIONS		Change D
					Leaf

Appr.

EXTERNAL CONNECTIONS

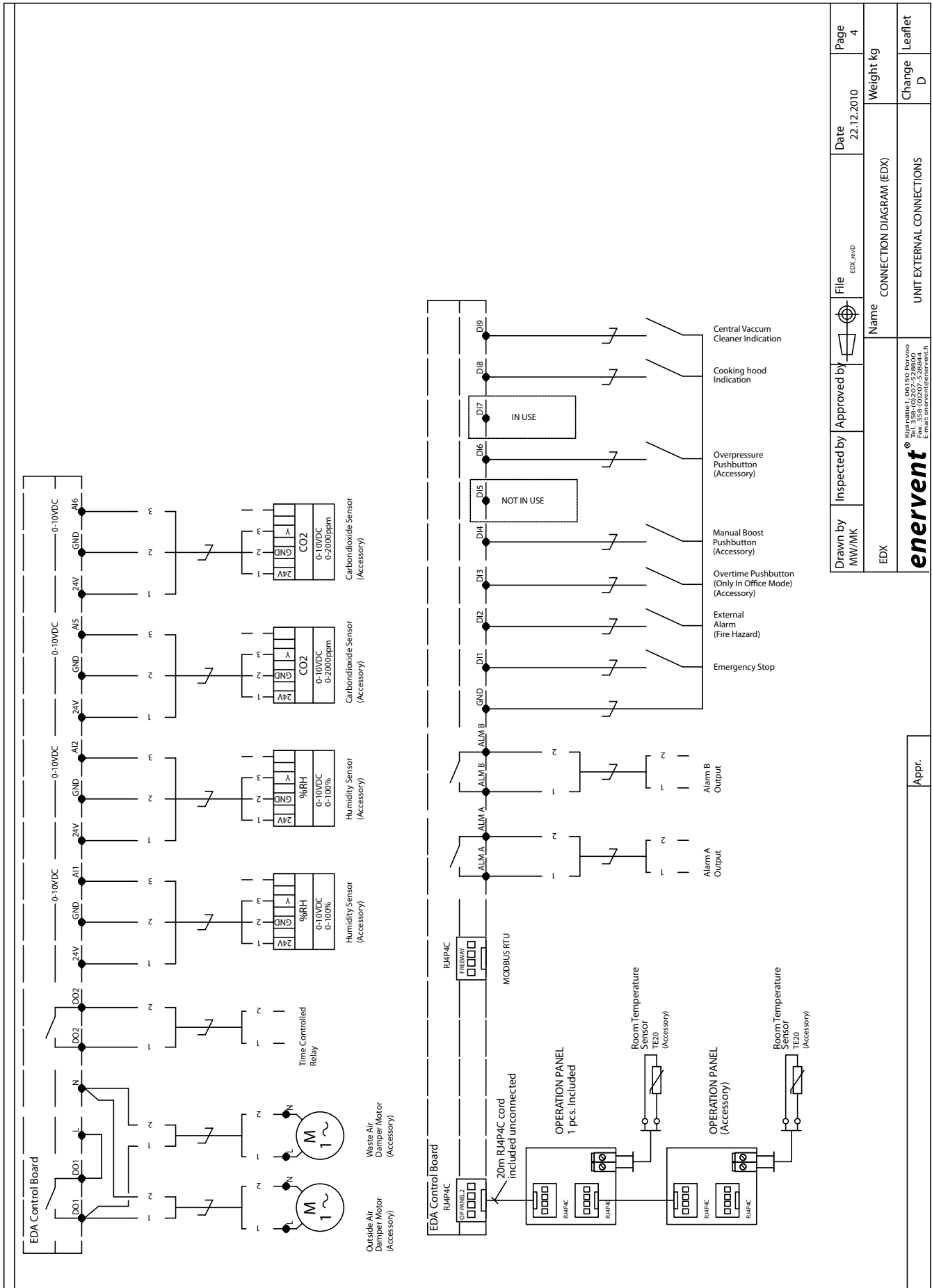

Drawn by MW/IMK	Inspected by EDX	Approved by	File EDX_REV.D	Date 22.12.2010	Page 4
Name CONNECTION DIAGRAM (EDX)			Weight kg		
Name UNIT EXTERNAL CONNECTIONS			Change D		

enervent
© 2011 enervent s.p.a. - Via S. Maria Maddalena, 10 - 37060 Sommacampagna (Verona) - Italy
 Tel. +39 0475 528800 - Fax. +39 0475 528804 - E-mail: enervent@enervent.com

Appr. _____

INSTRUCTIONS FOR SETTING PYR4

PYR 4 optimizes the heat pump efficiency in proportion to the air flow. This results in a quiet run.

The control signal to the EDX outside unit is proportioned to the air flow with the PYR4 converter, which is found in the ventilation unit connection box (Pingvin and LTR-3 units have an external connection box, the other models have an internal one). PYR4 is adjusted with the nob on the end of the converter, according to the curves for the outside unit in question, after achieved air flows have been measured at the building site. The new set value is written down both in the parameter list in this instruction ("RESTRICTIVE SIGNAL") and on the sticker on PYR4 ("CHANGED SETTING").

Example

Pingvin eco EDX-E unit, with a COMP1 outside unit. Measured normal air flow in the house is 75 l/s. According to the adjustment curve the set value for PYR4 is 75 %.

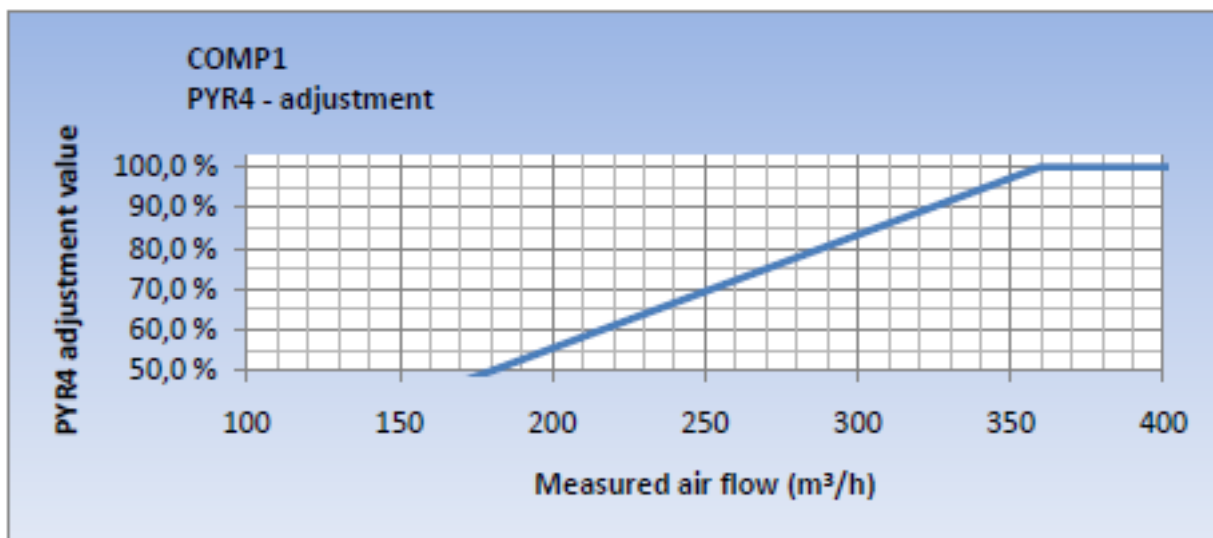

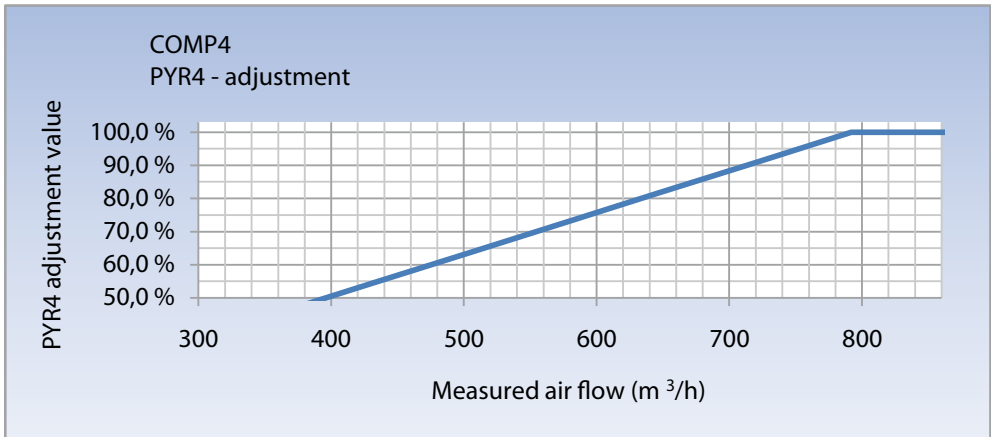
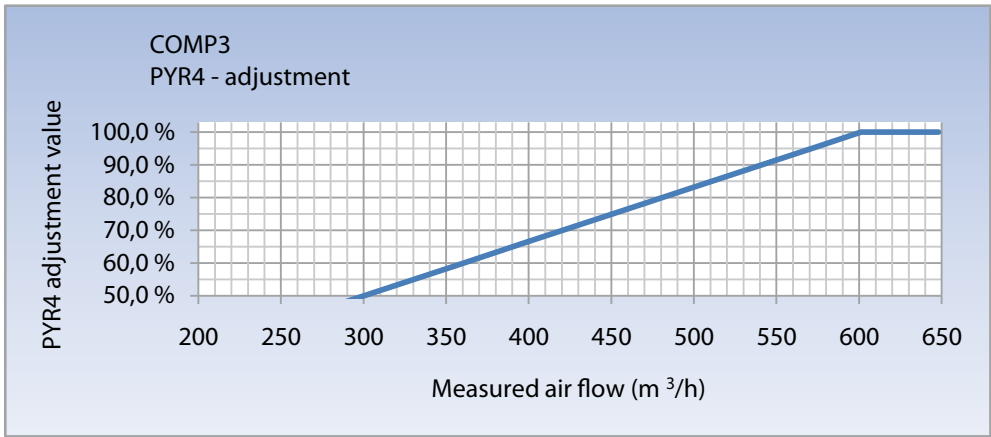
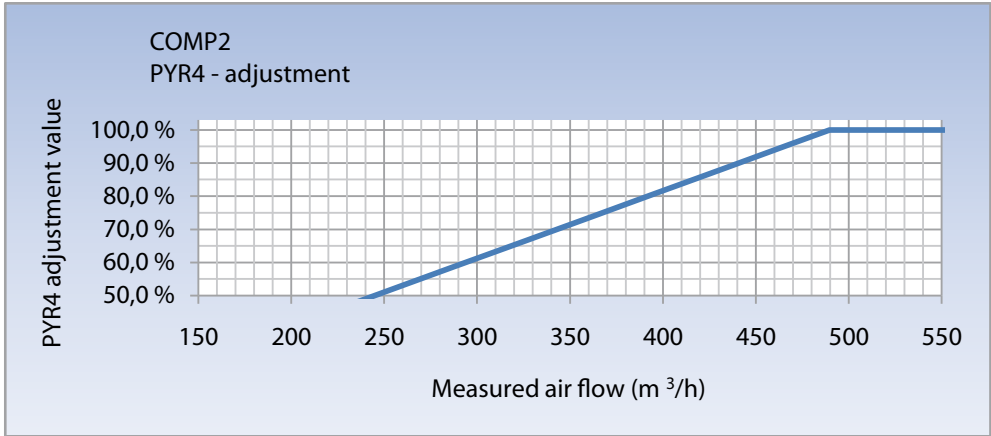
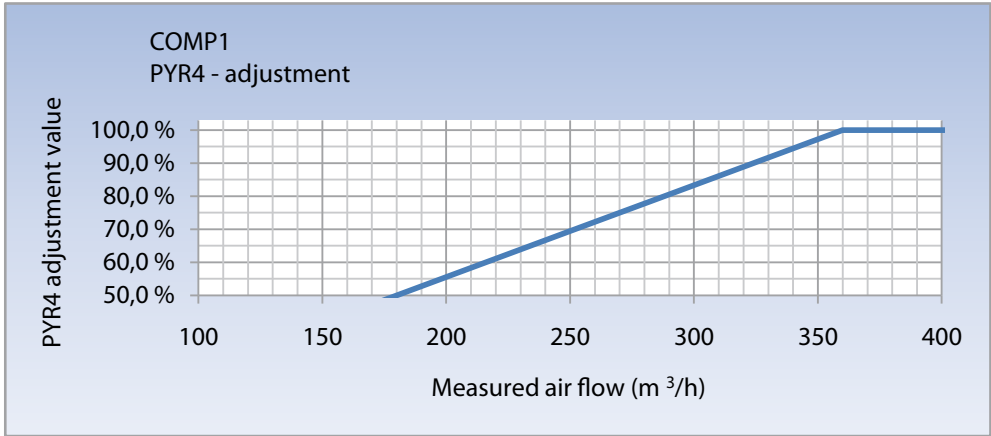

DECLARATION OF CONFORMITY

We declare that our products follow the provisions of low voltage directive (LVD) 2006/95/EEC, electro magnetic compatibility directive (EMC) 2004/108/EEC and machine directive (MD) 98/37/EEC.

Manufacturer: Enervent Oy
 Manufacturer's contact: Kipinätie 1, 06150 PORVOO FINLAND
 phone +358 (0)207 528 800, fax +358 (0)207 528 844
 enervent@enervent.fi, www.enervent.fi

Description of the product: Ventilation unit with heat recovery and heat pump

Trade name of the products: Enervent® Pingvin eco EDX-E
 Enervent® Pandion eco EDX-E
 Enervent® Pelican eco EDX-E
 Enervent® Pegasos eco (XL) EDX-E
 Enervent® LTR-3 eco EDX-E
 Enervent® LTR-6 eco EDX-E
 Enervent® LTR-7 eco (XL) EDX-E

Representatives for the products in the region of the ETA:

Sweden: Ventener Ab, Örelidsvägen 10, 517 71 OLSFORS, SVERIGE, tel +46 735-62 00 62
 Ventilair AB, Ulvsjövägen 68, 79699 ÄLVDALLEN, SVERIGE, tel +46 70 326 0759
 Climatprodukter AB, Box 366, 184 24 ÅKERSBERGA, SVERIGE, tel +46 8 540 87515
 DeliVent Ab, Markvägen 6, 43091 HÖNÖ, SVERIGE, tel +46 70 204 0809

Norway: Noram Produkter AS, Grini Næringspark 4 A, 1361 ØSTERÅS, NORGE, tel +47 33471245

Denmark: Covent EMJ, Donsvej 55, 6052 VIUF, DANMARK, tel + 45 7556 1534

Estonia: As Comfort Ae, Jaama 1, 72712 PAIDE, EESTI, tel +372 38 49 430

Ireland: Entropic Ltd., Unit 3, Block F, Maynooth Business Campus, Maynooth, Co. Kildare, IRELAND tel +353 64 34920

Germany: e4 energietechnik gmbh, Burgunderweg 2, 79232 MARCH, GERMANY, tel +49 7665 947 25 33

Austria: Inocal Wärmetechnik Gessellschaft m.b.H, Friedhofstrasse 4, 4020 LINZ, AUSTRIA, tel +43 732 65 03 910
 M-Tec Mittermayr GmbH, 4122 ARNREIT, AUSTRIA, tel +43 7282 7009-0

Poland: Iglotech, ul. Toruńska 41, 82-500 KWIDZYN, POLAND, tel +48 55 279 33 43

The products are in conformity with the following standards

LVD EN 60 335-1 (2002) +A1 (2004), +A2 (2006), +A11 (2004), +A12 (2006)
 MD EN ISO 12100-1 + A1 (2009), EN ISO 12100-2 +A1 (2009), EN ISO 14121-1 (2007)
 EMC EN 55014-1 (2006), EN 61 000-3-2 (2006) ja EN 61 000-3-3 (1995)
 EN 55014-2 (1997)+A1 (2001)

The conformity of each of our manufactured products is taken care according to our quality descriptions. This product was CE- marked in the year 2010.

Enervent Oy

Tom Palmgren
 Technology manager

THE PARAMETERS OF EDA CONTROL

ID	MENU	SUB MENU	PARAMETER	FACTORY SETTING	NOTE	FIELD SETTING
	Settings					
4x51	Fan speed	Normal spd	Supply fan	3 (30)		
4x52			Exhaust fan	3 (30)		
4x641			Ulkol.max	-10,0°C	Only PRO series units	
4x642			Ulkol.min	-0,1°C	Only PRO series units	
4x54		Over pressure	Supply fan	6 (80)		
4x55			Exhaust fan	5 (60)		
4x57			OP t	10 min		
4x58		Stove+CeVaCl+Overpr	CH Sply	6 (80)		
4x59			CH Exhst	5 (60)		
4x60			CVC Sply	6 (80)		
4x61			CVC Exhst	5 (60)		
4x62			COC Sply	7 (90)		
4x63			COC Exhst	5 (60)		
4x64			OCC Sply	8 (100)		
4x65			OCC Exhst	5 (60)		
1x23		YYY (Constant pressure)	Const. ductpr.			
4x645			CDPC EC P-a	2500 Pa		
4x646			CDPC EC I-t	5 s		
4x647			CDPC EC R-t	5 s		
4x648			CDPC EC Dz	2 Pa		
4x649			CDPC AC Delay	20 s		
4x650			CDPC AC Dz	10 Pa		
4x637			???	## Pa		
4x638			???	## Pa		
4x633			???	0 Pa		
4x635			???	200 Pa		
4x634			???	0 Pa		
4x636			???	200 Pa		
4x544			TV	600 s		
4x545			PV	600 s		
4x632			???	10 Pa		
4x10	Temperatures		Supply / Exhaust / Room measrnm	##°C	Depends on temepreature regulation mode	
4x8			Sply msrmnt	##°C		
4x136			Temp ctrl mde	Exhst	Exhaust control factory setting if the unit is equipped with cooling	
4x135			Setpoint	##°C		
4x140			Min	13,0°C		
4x141			Max	40,0°C		
1x56			OP 1	√		
1x57			OP 2			
1x58			OP 3			
1x59			OP 4			
1x60			OP 5			
1x61			Temp.trans 1			
1x62			Temp.trans 2			
1x63			Temp.trans 3			
	Boosting functions	Boosting settings				
4x66		Man. boost	Boost time	30 min		
4x67			Fanspd	7 (90)		
1x17		Humidity boost	Function	Fixed limit		
4x69			Humidity limit	50 %		
4x74			Max ventltn	8 (100)		
4x71			RH P-band	20 %		
4x73			RH I-time	1 min		

4x75			RH DZ	3 %		
4x72			Reset t	2 min		
4x76		CO2 boost	CO2 limit	1000 ppm		
4x77			Max ventltn	8 (100)		
4x78			CO2 P-band	200 ppm		
4x80			CO2 I-time	1 min		
4x81			CO2 DZ	50 ppm		
4x79			Reset t	1 min		
4x82		Temp. boost	Msrment	Exhaust temp		
4x83			Max ventltn	8 (100)		
4x84			T P-band	5,0°C		
4x86			T I-time	1 min		
4x87			T DZ	0,5°C		
4x85			Reset t	2 min		
4x88		Limit function	P-band	5,0°C		
4x90			I-time	1 min		
4x91			Neutral zone	0,5°C		
4x89			Reset t	2 min		
1x9	Boosting functions		Humidity			
1x8			Carbn dioxide			
1x11			Temp. boost			
4x100	Situation controls	Away	Fanspd	2 (30)		
4x101			Temp. drop	2,0°C		
1x18			Heat	√		
1x19			Cooling	√		
4x102		Long away	Fanspd	1 (20)		
4x103			Temp. drop	3,0°C		
1x20			Heat			
1x21			Cooling			
1x55		HRC	HR antifreez			
4x170			HRC t	-5,0°C		
4x168			HRC defr	30 Pa		
4x169			HRC delay	12 min		
1x64	Quick choice		Over pressure	√		
1x65			Boosting	√		
1x66			Away	√		
1x67			Long away	√		
1x68			Max heat	√		
1x69			Night cooling	√		
1x70			Fanspd settings	√		
1x71			Temperature ctrl	√		
4x140 - 4x141			Min-max	15°C - 30°C		
	Display settings		Backgrnd light on			
			Backgrnd light 60 s	√		
4x93	Night cooling		Snight out li	10,0°C		
4x94			Snight start	25,0°C		
4x95			Snight stop	21,0°C		
4x96			Snight dif	1,0°C		
4x92			Snight Fanspd	6 (80)		
1x15			Cool off	√		
4x98			Star	22		
4x99			Off	7		
4x97				Su Mo Tu We Th Fr Sa		
4x640	XXX (=General settings)		Modbus addr.	1		
4x199			Drive mode	HOME		To be defined on order
1x54			Heat	√		
1x52			Cooling	√		
1x53			HRC	√		
PYR4			Restrictive signal	100 %		To be adjusted when the unit is installed (see PYR4 instruction)